

# Panasonic®

## Operating Instructions

LCD Projector **Commercial Use**

Model No. **PT-LB51NTU**  
**PT-LB51U**  
**PT-LB51SU**

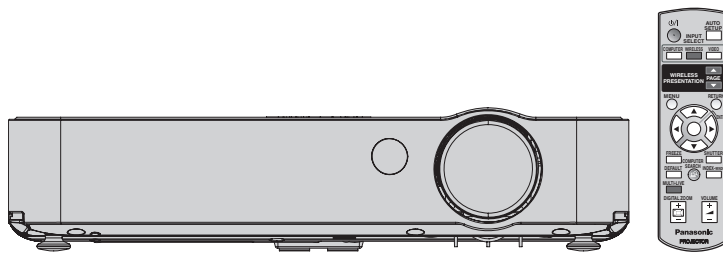

Before operating this product, please read the instructions carefully and save this manual for future use.

TQBJ0228-1

**ENGLISH**

# Important Safety Notice

## Dear Panasonic Customer:

This instruction booklet provides all the necessary operating information that you might require. We hope it will help you to get the most out of your new product, and that you will be pleased with your Panasonic LCD projector. The serial number of your product may be found on its bottom. You should note it in the space provided below and retain this booklet in case service is required.

Model number: **PT-LB51NTU / PT-LB51U / PT-LB51SU**

Serial number:

**WARNING:** TO REDUCE THE RISK OF FIRE OR ELECTRIC SHOCK, DONOT EXPOSE THIS PRODUCT TO RAIN OR MOISTURE.

**Power Supply:** This LCD Projector is designed to operate on 100 V - 240 V, 50 Hz/60 Hz AC, house current only.

**CAUTION:** The AC power cord which is supplied with the projector as an accessory can only be used for power supplies up to 125 V, 7 A. If you need to use higher voltages or currents than this, you will need to obtain a separate 250 V power cord. If you use the accessory cord in such situations, fire may result.

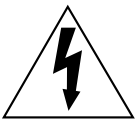

The lightning flash with arrowhead symbol, within an equilateral triangle, is intended to alert the user to the presence of uninsulated "dangerous voltage" within the product's enclosure that may be of sufficient magnitude to constitute a risk of electric shock to persons.



The exclamation point within an equilateral triangle is intended to alert the user to the presence of important operating and maintenance (servicing) instructions in the literature accompanying the product.

**CAUTION:** This equipment is equipped with a three-pin grounding-type power plug. Do not remove the grounding pin on the power plug. This plug will only fit a grounding-type power outlet. This is a safety feature. If you are unable to insert the plug into the outlet, contact an electrician. Do not defeat the purpose of the grounding plug.

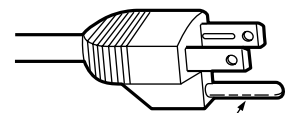

Do not remove

Indication based on the German law "Geräte- und Produktsicherheitsgesetz"

**Directive 2001/95/EC (Article 5);**

**Panasonic Marketing Europe GmbH**

**Hagenauer Str. 43 65203 Wiesbaden F.R.GERMANY**

**NOTICE:**

- This product has a High Intensity Discharge (HID) lamp that contains mercury. Dispose may be regulated in your community due to environmental considerations. For disposal or recycling information, please contact your local authorities, or the Electronics Industries Alliance: <http://www.eiae.org>

**WARNING:**

This equipment has been tested and found to comply with the limits for a Class B digital device, pursuant to Part 15 of the FCC Rules. These limits are designed to provide reasonable protection against harmful interference in a residential installation. This equipment generates, uses and can radiate radio frequency energy and, if not installed and used in accordance with the instructions, may cause harmful interference to radio communications. However, there is no guarantee that interference will not occur in a particular installation. If this equipment does cause harmful interference to radio or television reception, which can be determined by turning the equipment off and on, the user is encouraged to try to correct the interference by one or more of the following measures:

- Reorient or relocate the receiving antenna.
- Increase the separation between the equipment and receiver.
- Connect the equipment into an outlet on a circuit different from that to which the receiver is connected.
- Consult the dealer or an experienced radio/TV technician for help.

**FCC CAUTION:** To assure continued compliance, use only shielded interface cables when connecting to computers or peripheral devices. Any unauthorized changes or modifications to this equipment will void the users authority to operate.

If you use serial port to connect PC for external control of projector, you must use optional RS-232C serial interface cable with ferrite core. Any unauthorized changes or modifications to this equipment will void the user's authority to operate.

**FCC RF Exposure Warning:** (if provided with wireless device)

- This equipment complied with FCC radiation exposure limits set forth for an uncontrolled environment.
- This equipment has been approved for mobile operation and requires minimum 20 cm spacing be provided between antenna(s) and all person's body (excluding extremities of hands, wrist and feet) during wireless modes of operation.
- This equipment may not be used with other installed transmitters, which may be capable of simultaneous transmission.

**WARNING:**

- Not for use in a computer room as defined in the Standard for the Protection of Electronic Computer/Data Processing Equipment, ANSI/NFPA 75.
- For permanently connected equipment, a readily accessible disconnect device shall be incorporated in the building installation wiring.
- For pluggable equipment, the socket-outlet shall be installed near the equipment and shall be easily accessible.

**Declaration of Conformity**

Model Number: PT-LB51NTU / PT-LB51U / PT-LB51SU  
 Trade Name: **Panasonic**  
 Responsible party: Panasonic Corporation of North America  
 Address: One Panasonic Way, Secaucus, New Jersey 07094  
 Telephone number: (888) 411 - 1996  
 E-mail: projectorsupport@us.panasonic.com

This device complies with Part 15 of the FCC Rules. Operation is subject to the following two conditions: (1) This device may not cause harmful interference, and (2) this device must accept any interference received, including interference that may cause undesired operation.

**Information on Disposal in other Countries outside the European**



This symbol is only valid in the European Union.

If you wish to discard this product, please contact your local authorities or dealer and ask for the correct method of disposal.

# Contents

## Quick steps

**1. Set up your projector**  
See “Setting up” on page 14.



**2. Connect with other devices**  
See “Connections” on page 18.



**3. Prepare the Remote control**  
See “Remote control” on page 10.



**4. Start projecting**  
See “Switching the projector on/off” on page 20.



**5. Adjust the image**  
See “Positioning the image” on page 22.

## Important Information

<b>Important Safety Notice</b> .....	<b>2</b>
<b>Precautions with regard to safety</b> .....	<b>6</b>
WARNINGS .....	6
CAUTIONS .....	7
Cautions when transporting .....	8
Cautions when installing .....	8
Cautions on use .....	9
Accessories .....	9

## Preparation

<b>About Your Projector</b> .....	<b>11</b>
Remote control .....	11
Projector body .....	12

## Getting Started

<b>Setting up</b> .....	<b>14</b>
Screen size and throw distance .....	14
Projection method .....	16
Front leg adjusters and throwing angle .....	17
<b>Connections</b> .....	<b>18</b>
Before connection to the projector .....	18
Connecting with computers .....	18
Connecting with AV equipment .....	19

## Basic Operation

<b>Switching the projector on/off</b> .....	<b>20</b>
Power cord .....	20
POWER indicator .....	20
Switching on the projector .....	21
Switching off the projector .....	21
<b>Projecting an image</b> .....	<b>22</b>
Selecting the input signal .....	22
Positioning the image .....	22
<b>Remote control operation</b> .....	<b>23</b>
Operating range .....	23
Setting up the image position automatically .....	23
Switching the input signal .....	24
Capturing an image .....	25
Stopping the projection temporary .....	25
Resetting to the factory default settings .....	25
Projecting an image in INDEX-WINDOW mode .....	25
Enlarging the centered area .....	26
Controlling the volume of the speaker .....	26

## Settings

<b>Menu Navigation</b> .....	<b>27</b>
Navigating through the MENU .....	27
Main menu and Sub-menu .....	28
<b>PICTURE menu</b> .....	<b>30</b>
PICTURE MODE .....	30
CONTRAST .....	30
BRIGHTNESS .....	30
COLOR .....	30
TINT .....	30
SHARPNESS .....	30
COLOR TEMPERATURE .....	30
DAYLIGHT VIEW .....	31
AI .....	31
DETAILED SETUP .....	31
<b>POSITION menu</b> .....	<b>32</b>
REALTIME KEYSTONE .....	32
KEYSTONE .....	32
POSITION .....	32
DOT CLOCK .....	32
CLOCK PHASE .....	32
ASPECT .....	32
RESIZING .....	33
FRAME LOCK .....	33
<b>LANGUAGE menu</b> .....	<b>33</b>
<b>OPTION menu</b> .....	<b>34</b>
INPUT GUIDE .....	34
STARTUP LOGO .....	34
FUNCTION BUTTON .....	34
COMPUTER2 SELECT .....	34
LAMP POWER .....	34
LAMP RUNTIME .....	35
POWER OFF TIMER .....	35
DIRECT POWER ON .....	35
CONTROL PANEL .....	35
AUTO SETUP .....	35
SIGNAL SEARCH .....	35
INSTALLATION .....	35
HIGHLAND .....	36
RGB/YPBPR .....	36
VOLUME .....	36
DETAILED SETUP .....	36
<b>SECURITY menu</b> .....	<b>37</b>
INPUT PASSWORD .....	37
PASSWORD CHANGE .....	37
TEXT DISPLAY .....	37
TEXT CHANGE .....	37
<b>WIRELESS menu (PT-LB51NTU only)</b> .....	<b>38</b>
Items in WIRELESS menu .....	38

## Maintenance

<b>TEMP and LAMP Indicators</b> .....	<b>39</b>
Managing the indicated problems .....	39
<b>Care and Replacement</b> .....	<b>40</b>
Cleaning the projector .....	40
Replacing the air filter .....	40
Replacing the Lamp unit .....	41
<b>Troubleshooting</b> .....	<b>43</b>

## Appendix

<b>Technical Information</b> .....	<b>44</b>
List of compatible signals .....	44
Serial terminal .....	45
Computer connection guidance .....	47
Specifications .....	48
Dimensions .....	51
Trademark acknowledgments .....	51
<b>Index</b> .....	<b>52</b>
<b>Avis important concernant la sécurité</b> .....	<b>54</b>
<b>Précautions de sécurité</b> .....	<b>56</b>
AVERTISSEMENT .....	56
MISES EN GARDE .....	57
Précautions lors du transport .....	58
Précautions lors de l'installation .....	59
Précautions lors de l'utilisation .....	59
<b>Remplacement de l'unité de la lampe</b> .....	<b>60</b>

# Precautions with regard to safety

## WARNINGS

**If you notice smoke, strange smells or noise coming from the projector, disconnect the power cord plug from the wall outlet.**

- Do not continue to use the projector in such cases, otherwise fire or electric shocks could result.
- Check that no more smoke is coming out, and then contact an Authorised Service Center for repairs.
- Do not attempt to repair the projector yourself, as this can be dangerous.

**Do not install this projector in a place which is not strong enough to take the full weight of the projector.**

- If the installation location is not strong enough, it may fall down or tip over, and severe injury or damage could result.

**Installation work (such as ceiling suspension) should only be carried out by a qualified technician.**

- If installation is not carried out correctly, there is the danger that injury or electric shocks may occur.
- Do not use other than an authorised ceiling mount bracket.

**If foreign objects or water get inside the projector, or if the projector is dropped or the cabinet is broken, disconnect the power cord plug from the wall outlet.**

- Continued use of the projector in this condition may result in fire or electric shocks.
- Contact an Authorised Service Center for repairs.

**Do not overload the wall outlet.**

- If the power supply is overloaded (for example, by using too many adapters), overheating may occur and fire may result.

**Never attempt to modify or disassemble the projector.**

- High voltages can cause fire or electric shocks.
- For any inspection, adjustment and repair work, please contact an Authorised Service Center.

**Clean the power cord plug regularly to prevent it from becoming covered in dust.**

- If dust builds up on the power cord plug, the resulting humidity can damage the insulation, which could result in fire. Pull the power cord plug out from the wall outlet and wipe it with a dry cloth.
- If not using the projector for an extended period of time, pull the power cord plug out from the wall outlet.

**Do not handle the power cord plug with wet hands.**

- Failure to observe this may result in electric shocks.

**Insert the power cord plug securely into the wall outlet.**

- If the plug is not inserted correctly, electric shocks or overheating could result.
- Do not use plugs which are damaged or wall outlet which are coming loose from the wall.

**Do not place the projector on top of surfaces which are unstable.**

- If the projector is placed on top of a surface which is sloped or unstable, it may fall down or tip over, and injury or damage could result.

**Do not place the projector into water or let it become wet.**

- Failure to observe this may result in fire or electric shocks.

**Do not do anything that might damage the power cord or the power cord plug.**

- Do not damage the power cord, make any modifications to it, place it near any hot objects, bend it excessively, twist it, pull it, place heavy objects on top of it or wrap it into a bundle.
- If the power cord is used while damaged, electric shocks, short-circuits or fire may result.
- Ask an Authorised Service Center to carry out any repairs to the power cord that might be necessary.

**Do not place the projector on soft materials such as carpets or sponge mats.**

- Doing so may cause the projector to overheat, which can cause burns, fire or damage to the projector.

**Do not place liquid containers on top of the projector.**

- If water spills onto the projector or gets inside it, fire or electric shocks could result.
- If any water gets inside the projector, contact an Authorised Service Center.

**Do not insert any foreign objects into the projector.**

- Do not insert any metal objects or flammable objects into the projector or drop them onto the projector, as doing so can result in fire or electric shocks.

**Do not allow the + and - terminals of the batteries to come into contact with metallic objects such as necklaces or hairpins.**

- Failure to observe this may cause the batteries to leak, overheat, explode or catch fire.
- Store the batteries in a plastic bag and keep them away from metallic objects.

**Do not touch the leaked liquid from the batteries.**

- If you touch the leaked liquid, it may hurt your skin. Immediately wash away the liquid with water and seek medical advice.
- If you get the leaked liquid in your eye, it may cause blindness or damage. Never rub your eye, and immediately wash away the liquid with water and seek medical advice.

**During a thunderstorm, do not touch the projector or the cable.**

- Electric shocks can result.

**Do not use the projector in a bath or shower.**

- Fire or electric shocks can result.

## Precautions with regard to safety

### Do not place your skin into the light beam while the projector is being used.

- Strong light is emitted from the projector's lens. If you place directly into this light, it can hurt or damage your skin.

### Do not look into the lens while the projector is being used.

- Strong light is emitted from the projector's lens. If you look directly into this light, it can hurt and damage your eyes.
- Be especially careful not to let young children look into the lens. In addition, turn off the power and disconnect the power cord plug when you are away from the projector.

### Do not place your hands or other objects close to the air outlet port.

- Heated air comes out of the air outlet port. Do not place your hands or face, or objects which cannot withstand heat close to this port [allow at least 15 cm (6") of space], otherwise burns or damage could result.

### Replacement of the lamp is recommended to be carried out by a qualified technician.

- The lamp has high internal pressure. If improperly handled, explosion might result.
- The lamp can easily become damaged if struck against hard objects or dropped, and injury or malfunctions may result.

### When replacing the lamp, allow it to cool for at least one hour before handling it.

- The lamp cover gets very hot, and touching it can cause burns.

### Before replacing the lamp, be sure to disconnect the power cord plug from the wall outlet.

- Electric shocks or explosions can result if this is not done.

### Do not allow infants or pets to touch the remote control unit.

- Keep the remote control unit out of the reach of infants and pets after using it.

### Do not set up the projector outdoor.

- The projector is designed for indoor use only.

### Dispose of unneeded power cords, cap and packaging materials appropriately after removing the product.

## CAUTIONS

### Do not cover the air inlet port or the air outlet port.

- Doing so may cause the projector to overheat, which can cause fire or damage to the projector.
- Do not place the projector in narrow, badly ventilated places such as closets or bookshelves.
- Do not place the projector on cloth or papers, as these materials could be drawn into the air inlet port.

### Do not set up the projector in humid or dusty places or in places where the projector may come into contact with oily smoke or steam.

- Using the projector under such conditions may result in fire, electric shocks or plastic deterioration. The plastic deterioration may cause the falling down of the projector which is mounted in the ceiling.

### Do not set up the projector in a high temperature environment, such as near a heater or in direct sunlight.

- Failure to observe this may result in fire, malfunction or plastic deterioration.

### When disconnecting the power cord, hold the plug, not the cord.

- If the power cord itself is pulled, the cord will become damaged, and fire, short-circuits or serious electric shocks may result.

### Always disconnect all cables before moving the projector.

- Moving the projector with cables still attached can damage the cables, which could cause fire or electric shocks to occur.

### Do not place any heavy objects on top of the projector.

- Failure to observe this may cause the projector to become unbalanced and fall, which could result in damage or injury.

### Do not short-circuit, heat or disassemble the batteries or place them into water or fire.

- Failure to observe this may cause the batteries to overheat, leak, explode or catch fire, and burns or other injury may result.

### When inserting the batteries, make sure the polarities (+ and -) are correct.

- If the batteries are inserted incorrectly, they may explode or leak, and fire, injury or contamination of the battery compartment and surrounding area may result.

### Use only the specified batteries.

- If incorrect or different kind of batteries are used, they may explode or leak, and fire, injury or contamination of the battery compartment and surrounding area may result.

## Precautions with regard to safety

### Do not mix old and new batteries.

- If the batteries are inserted incorrectly, they may explode or leak, and fire, injury or contamination of the battery compartment and surrounding area may result.

### Remove the used batteries from the remote control promptly.

- If you leave used batteries in the remote control for an extended period of time, it may cause liquid leaking, abnormal internal temperature rising or explosion.

### If not using the projector for an extended period of time, disconnect the power cord plug from the wall outlet and remove the batteries from the remote control.

- If dust builds up on the power cord plug, the resulting humidity may damage the insulation, which could result in fire.
- Keeping or leaving the remote control with batteries inside may cause insulation deterioration, electrical leakage or explosion which could result in fire.

### Do not put your weight on this projector.

- You could fall or the projector could break, and injury may result.
- Be especially careful not to let young children stand or sit on the projector.

We are constantly making efforts to preserve and maintain a clean environment. Please take non repairable units back to your dealer or a recycling company.

### Disconnect the power cord plug from the wall outlet as a safety precaution before carrying out any cleaning.

- Electric shocks can result if this is not done.

### If the lamp has broken, ventilate the room immediately. Do not touch or bring your face close to the broken pieces.

- Failure to observe this may cause the user to absorb the gas which was released when the lamp broke and which contains nearly the same amount of mercury as fluorescent lamps, and the broken pieces may cause injury.
- If you believe that you have absorbed the gas or that the gas has got into your eyes or mouth, seek medical advice immediately.
- Ask your dealer about the replacement of the lamp unit and check the inside of the projector.

### Ask an Authorised Service Center to clean inside the projector at least once a year.

- If dust is left to build up inside the projector without being cleaned out, it can result in fire or problems with operation.
- It is a good idea to clean the inside of the projector before the season for humid weather arrives. Ask your nearest Authorised Service Center to clean the projector when required. Please discuss with the Authorised Service Center regarding cleaning costs.

## Cautions when transporting

### Do not subject the projector to excessive vibration or shocks.

- The projector lens need to be handled with care.

### Be sure to use the accessory carrying bag when moving the projector.

- When placing the projector inside the carrying bag, position it so that the lens is facing upward. Do not place the projector with its adjustable legs extended and do not put anything else in the bag other than the projector, cables and the remote control unit.

## Cautions when installing

### Avoid setting up in places which are subject to vibration or shocks.

- The internal parts can be damaged, which may cause malfunctions or accidents.

### Avoid setting up in places which are subject to sudden temperature changes, such as near an air conditioner or lighting equipment.

- The life of the lamp may be shortened or the projector may be turned off. See "TEMP indicator" on page 40.

### Do not set up the projector near high-voltage power lines or near motors.

- The projector may be subject to electromagnetic interference.

### If installing the projector to the ceiling, ask a qualified technician to carry out all installation work.

- You will need to purchase the separate installation kit (Model No. ET-PKB50). Furthermore, all installation work is should only be carried out by a qualified technician.

### If using this projector at high elevations (above 1 400 m), set the HIGHLAND to ON. See "HIGHLAND" on page 36.

- Failure to observe this may result in malfunctions or the life of the lamp or the other components may be shortened.



## Cautions on use

### In order to get the best picture quality

- Draw curtains or blinds over any windows and turn off any lights near the screen to prevent outside light or light from indoor lamps from shining onto the screen.

### Do not touch the surfaces of the lens with your bare hands.

- If the surface of the lens becomes dirty from fingerprints or anything else, this will be magnified and projected onto the screen.

### Liquid crystal panel

- Do not project the same image for long periods of time, as this may remain as an afterimage on the liquid crystal panel.
- The liquid crystal panel of the projector is built with very high precision technology to provide fine picture details. Occasionally, a few stuck pixels may appear on the screen as fixed points of blue, green or red. It is recommended to switch off the projector once and try after 1 hour later again. Please note that this does not affect the performance of your LCD.

### Screen

- Do not apply any volatile substances which may cause discoloration to the screen, and do not let it become dirty or damaged.

### The projector has a high pressure mercury lamp and that is characterized as follows.



- The brightness of the lamp depends on the duration of use.
- The lamp may explode or shorten the lamp life by shocks or chipping damage.
- The lamp may explode only occasionally after using the projector.
- The lamp may explode if using the projector after the instructed lamp replacement timing.
- The lamp life is depends on individual lamp characteristics, usage condition and the installation environment. Especially the consecutive use of the projector for more than 10 hours, or the frequent switching on or off may greatly affect on the lamp life.

### Optical components

- If you use the projector consecutively 6 hours every day, the optical components may need to be replaced in less than 1 year.

## Accessories

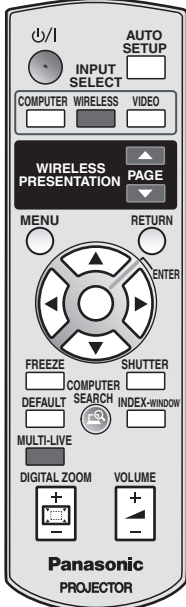
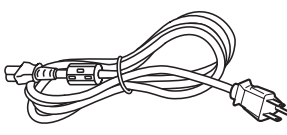
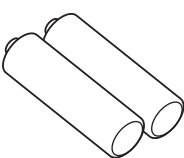
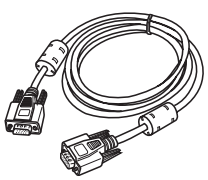
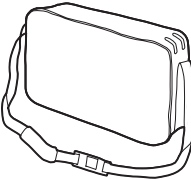
Make sure the following accessories are provided with your projector.

<p><b>Remote control*</b> PT-LB51NTU : N2QAYB000169 (X1) PT-LB51U /PT-LB51SU : N2QAYB000172 (X1)</p>  <p><b>Panasonic</b> PROJECTOR</p> <p>*The illustration above is the remote control unit for the PT-LB51NTU.</p>	<p><b>Power cord (x1)</b> TXFSX02QHRZ</p> 	<p><b>AA batteries for Remote control (x2)</b></p> 	<p><b>RGB signal cable (x1)</b> [1.8 m (5' 10"), K1HA15DA0002 x1]</p> 
	<p><b>Carrying bag (x1)</b> (TPEP018)</p> 	<p><b>CD-ROM* (x1)</b> TQBH9009</p>  <p>*PT-LB51NTU only</p>	

# About Your Projector

## Remote control

**POWER** button  
Switch between stand-by mode and projection mode. (page 20)

**AUTO SETUP**  
Automatically adjust the setting of **DOT CLOCK**, **CLOCK PHASE** for the projected image of **COMPUTER** signal. (page 23)

**COMPUTER** **INPUT SELECT** buttons  
Switch the required input signal button to select.

**WIRELESS** **WIRELESS** button is only for PT-LB51NTU.  
● see **CD-ROM** contents.

**VIDEO**

**PAGE** buttons is only for PT-LB51NTU.  
● See **CD-ROM** contents.

**RETURN** Return to the previous menu. (page 27)

**SHUTTER** Turn off the projection temporarily. (page 24)

**INDEX-WINDOW** Display the frozen image while the display of subsequent images continues. (page 25)

**COMPUTER SEARCH** **COMPUTER SEARCH** button is only for PT-LB51NTU.  
● See **CD-ROM** contents.

**MENU**  
Display the **MAIN MENU**. (page 27)

Navigate through the menus with **▲▼◀▶**, and activate the menu item with **ENTER**. (page 27)

**FREEZE**  
Capture the projected image as a frozen picture. (page 24)

**DEFAULT**  
Reset some of the settings to the factory default settings. (page 25)

**MULTI-LIVE** button is only for PT-LB51NTU.  
● See **CD-ROM** contents.

**DIGITAL ZOOM**  
Control to change the scale by means of digital zoom. (page 26)

**VOLUME** Control to adjust the volume of the speakers. (page 26)

### Battery compartment

1. Press the tab and lift up the cover.
2. Insert the batteries according to the polarity diagram indicated inside.



### Top view

Remote control signal emitter. (page 23)

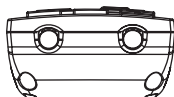

### Attaching a hand strap

You can attach a favorite strap on to the **Remote control**.

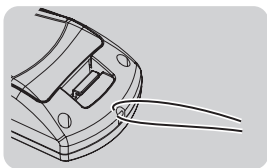

#### NOTE:

- Do not drop the **Remote control**.
- Avoid contact with liquids or moisture.
- Use manganese batteries or alkaline batteries with the **Remote control**.
- Do not attempt to modify or disassemble the **Remote control**. Contact an Authorised Service Center for repairs.
- Do not keep pressing the **Remote control** buttons as this may shorten battery life.
- See “Remote control operation” on page 23.

# About Your Projector

## Projector body

### Top and front view

Preparation

**LAMP** indicator (page 39)

**Luminance Sensor**

(page 31)

This sensor detects the luminance when the "DAYLIGHT VIEW" function is operating. Do not cover the projector and do not place any object on the projector when using it.

**COMPUTER INPUT** indicator

This indicator illuminates when a signal is being input to the connector (COMPUTER1 IN or COMPUTER 2 IN) selected using the **INPUT SELECT** buttons.

**TEMP** indicator (page 39)

**Control panel**

**Font leg adjuster**

(L) button (page 17)

These buttons are used to unlock the front adjustable legs. Press to adjust the angle of tilt of the projector.

**Remote control signal receptor** (page 23)

**Projection lens**

**Zoom ring** (page 22)

**Focus ring** (page 22)

**Font leg adjuster (R) button** (page 17)

**Security lock**

This can be used to connect a commercially-available theft-prevention cable (manufactured by Kensington). This security lock is compatible with the Microsaver Security System from Kensington.

### Control panel

**INPUT SELECT** button (page 22)

Switch to cycle through the input method.

**POWER** button (page 20)

**POWER** indicator (page 20)

Switch between stand-by mode and projection mode.

**Navigation** buttons (page 27)

Navigate through the menus with **▲▼◀▶**, and activate the menu item with **ENTER**.

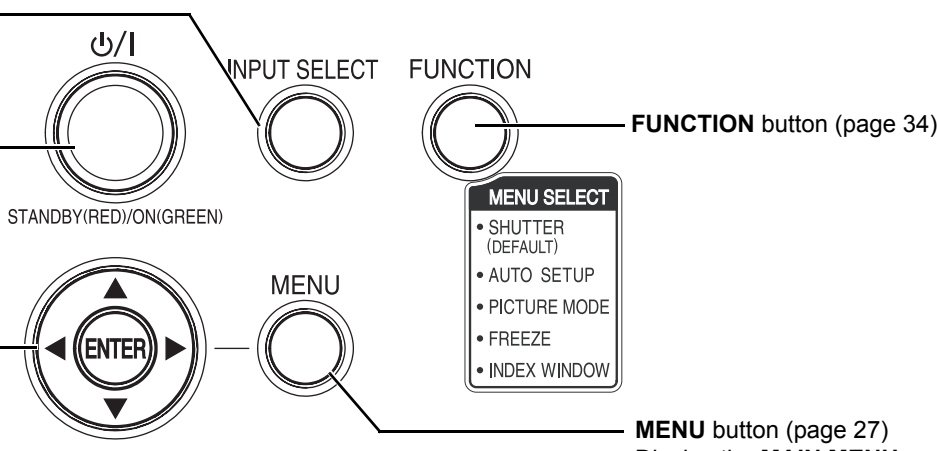

**NOTE:**

- Do not cover the ventilation openings or place anything within 15 cm (6") of them as this may cause damage or injury.

## Back and bottom view

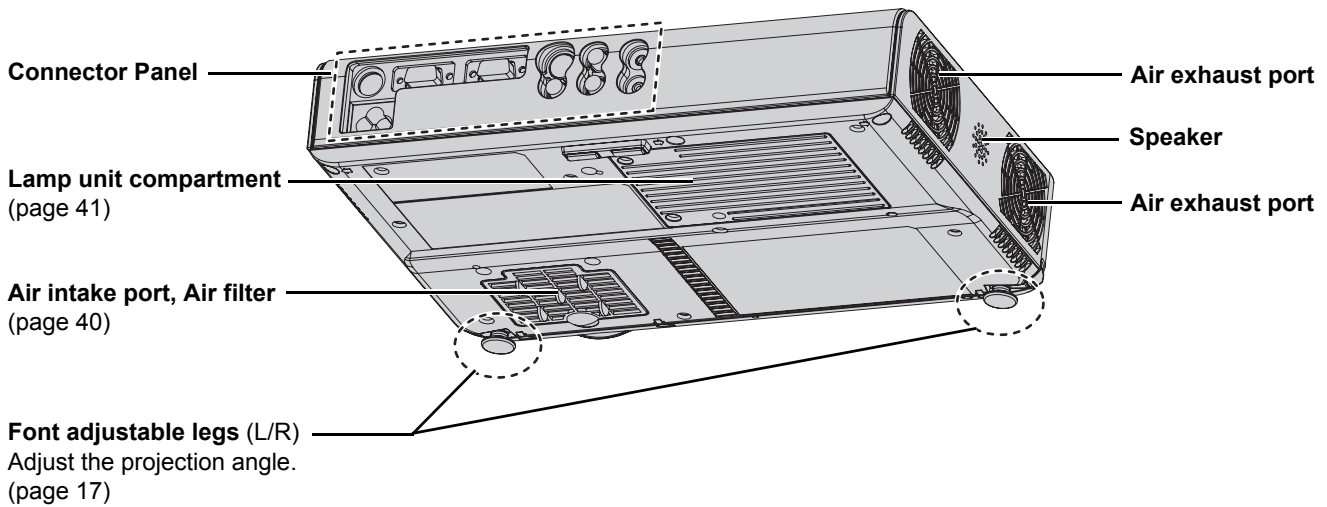

## Connector Panel

### COMPUTER2 IN/1 OUT

Connect an RGB signal cable from a computer. Selectable for input and output by menu operation.

### COMPUTER1 IN

Connect an RGB signal cable from a computer.

### SERIAL

See "Serial terminal" on page 45.

### AC IN

Connect the **Power cord** to supply electronic power to the projector. (page 20)

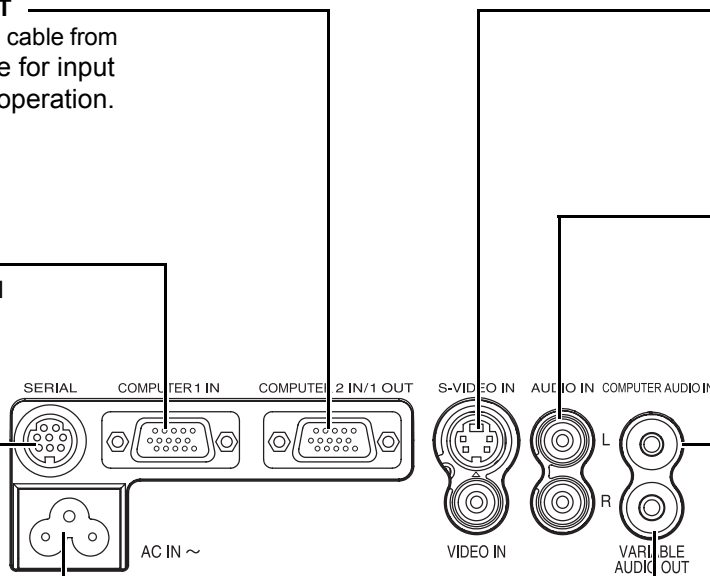

### S-VIDEO IN

Connect a S-VIDEO signal cable.

### VIDEO IN

Connect an RCA composite video cable.

### AUDIO IN

Connect audio cables for inputting audio signal corresponding to **VIDEO IN**, **S-VIDEO IN** and **COMPONENT IN**.

### COMPUTER AUDIO IN

Connect audio cables for inputting audio signals corresponding to **COMPUTER1 IN** and **COMPUTER2 IN/1 OUT**.

### VARIABLE AUDIO OUT

Connect an audio cables for outputting audio signals to the connected equipment.

### NOTE:

- Do not cover the ventilation openings or place anything within 15 cm (6") of them as this may cause damage or injury.
- When a cable is connected to the **VARIABLE AUDIO OUT**, the built-in speaker will be disabled.

# Setting up

## Screen size and throw distance

You can adjust the projection size with 1.2x zoom lens. Calculate and define the throw distance as follows.

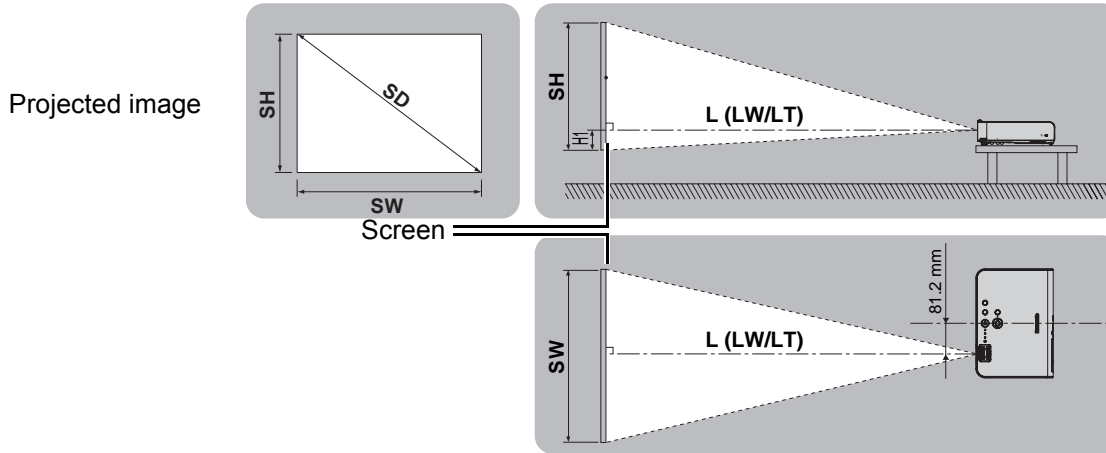

### PT-LB51NTU/PT-LB51U

Projection size (4 : 3)			Throw distance (L)		Height position (H1)
Screen diagonal (SD)	Screen height (SH)	Screen width (SW)	Minimum distance (LW)	Maximum distance (LT)	
33" (0.84 m)	0.50 m (1'7")	0.67 m (2'2")		1.1 m (3'7")	0.07 m (2-3/4")
40" (1.02 m)	0.61 m (2')	0.81 m (2'7")	1.2 m (3'11")	1.4 m (4'7")	0.08 m (3-1/8")
50" (1.27 m)	0.76 m (2'5")	1.02 m (3'4")	1.6 m (5'2")	1.8 m (5'10")	0.11 m (4-5/16")
60" (1.52 m)	0.91 m (2'11")	1.22 m (4')	1.9 m (6'2")	2.1 m (6'10")	0.13 m (5-3/32")
70" (1.78 m)	1.07 m (3'06")	1.42 m (4'7")	2.2 m (7'2")	2.5 m (8'2")	0.15 m (5-7/8")
80" (2.03 m)	1.22 m (4')	1.63 m (5'4")	2.5 m (8'2")	2.9 m (9'6")	0.17 m (6-11/16")
90" (2.29 m)	1.37 m (4'5")	1.83 m (6')	2.8 m (9'2")	3.3 m (10'9")	0.19 m (7-15/32")
100" (2.54 m)	1.52 m (4'11")	2.03 m (6'7")	3.1 m (10'2")	3.6 m (11'9")	0.21 m (8-1/4")
120" (3.05 m)	1.83 m (6')	2.44 m (8')	3.7 m (12'1")	4.4 m (14'5")	0.25 m (9-13/16")
150" (3.81 m)	2.29 m (7'6")	3.05 m (10')	4.6 m (15'1")	5.5 m (18)	0.32 m (12-19/32")
200" (5.08 m)	3.05 m (10')	4.06 m (13'3")	6.2 m (20'4")	7.3 m (23'11")	0.42 m (16-17/32")
250" (6.35 m)	3.81 m (12'6")	5.08 m (16'8")	7.7 m (25'3")	9.2 m (30'2")	0.53 m (20-27/32")
300" (7.62 m)	4.57 m (14'11")	6.10 m (20')	9.2 m (30'2")	11.1 m (36'5")	0.64 m (25-3/16")

### PT-LB51SU

Projection size (4 : 3)			Throw distance (L)		Height position (H1)
Screen diagonal (SD)	Screen height (SH)	Screen width (SW)	Minimum distance (LW)	Maximum distance (LT)	
33" (0.84 m)	0.50 m (1'7")	0.67 m (2'2")		1.1 m (3'7")	0.07 m (2-3/4")
40" (1.02 m)	0.61 m (2')	0.81 m (2'7")	1.2 m (3'11")	1.4 m (4'7")	0.09 m (3-17/32")
50" (1.27 m)	0.76 m (2'5")	1.02 m (3'4")	1.5 m (4'11")	1.8 m (5'10")	0.11 m (4-5/16")
60" (1.52 m)	0.91 m (2'11")	1.22 m (4')	1.8 m (5'10")	2.1 m (6'10")	0.13 m (5-3/32")
70" (1.78 m)	1.07 m (3'06")	1.42 m (4'7")	2.1 m (6'10")	2.5 m (8'2")	0.15 m (5-7/8")
80" (2.03 m)	1.22 m (4')	1.63 m (5'4")	2.5 m (8'2")	2.9 m (9'6")	0.17 m (6-11/16")
90" (2.29 m)	1.37 m (4'5")	1.83 m (6')	2.8 m (9'2")	3.2 m (10'5")	0.20 m (7-27/32")
100" (2.54 m)	1.52 m (4'11")	2.03 m (6'7")	3.1 m (10'2")	3.6 m (11'9")	0.22 m (8-21/32")
120" (3.05 m)	1.83 m (6')	2.44 m (8')	3.7 m (12'1")	4.3 m (14'1")	0.26 m (10-7/32")
150" (3.81 m)	2.29 m (7'6")	3.05 m (10')	4.6 m (15'1")	5.4 m (17'8")	0.33 m (12-31/32")
200" (5.08 m)	3.05 m (10')	4.06 m (13'3")	6.1 m (20)	7.3 m (23'11")	0.43 m (16-29/32")
250" (6.35 m)	3.81 m (12'6")	5.08 m (16'8")	7.6 m (24'11")	9.1 m (29'10")	0.54 m (21-1/4")
300" (7.62 m)	4.57 m (14'11")	6.10 m (20')	9.1 m (29'10")	10.9 m (35'9")	0.65 m (25-9/16")

\* All measurements above are approximate and may differ slightly from the actual measurements.

## Calculation methods for screen dimensions

You can calculate more detailed screen dimension from the screen diagonal. (Unit: m)

### PT-LB51NTU/PT-LB51U

● Projection size(4:3)	
SH	= SD X 0.0152
SW	= SD X 0.0203
LW	= 0.0307 X SD - 0.031
LT	= 0.0371 X SD - 0.029

● Projection size(16:9)	
SH	= SD X 0.0125
SW	= SD X 0.0221
LW	= 0.0335 X SD - 0.0315
LT	= 0.0405 X SD - 0.0365

### PT-LB51SU

● Projection size(4:3)	
SH	= SD X 0.0152
SW	= SD X 0.0203
LW	= 0.0304 X SD - 0.029
LT	= 0.0368 X SD - 0.041

● Projection size(16:9)	
SH	= SD X 0.0125
SW	= SD X 0.0221
LW	= 0.0332 X SD - 0.032
LT	= 0.0401 X SD - 0.038

\* The results above are approximate and may differ slightly from the actual measurements.

#### NOTE:

- Do not use the projector at a raised or a horizontally tilted position as it may cause malfunction of the projector.
- Make sure the projector lens surface is parallel with the screen. You can tilt the projector body approximately  $\pm 30^\circ$  vertically. Overtilting may result in shortening the component's life.
- For the best quality of the projection image, install a screen where sun light or room light does not shine directly onto the screen. Close window shades or curtains to block the lights.

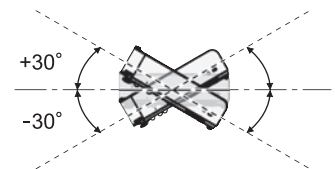

### Projection method

You can use the projector with any of the following 4 projection methods. To set the desired method in the projector, See "INSTALLATION" on page 35..

#### ■ Setting on a desk/floor and projecting from front

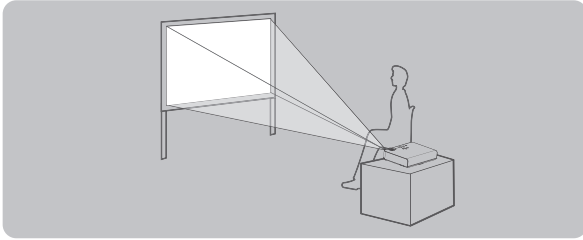

INSTALLATION: FRONT/DESK

#### ■ Setting on a desk/floor and projecting from rear

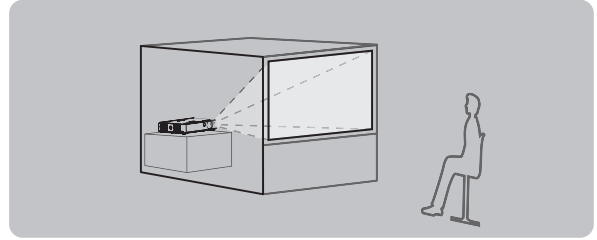

INSTALLATION: REAR/DESK

#### ■ Mounting in the ceiling and projecting from front

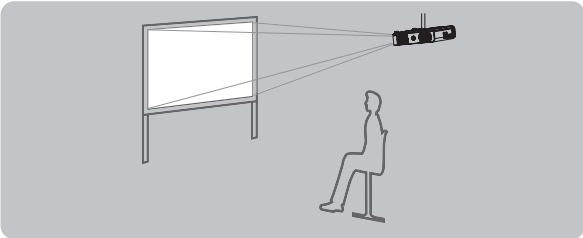

INSTALLATION: FRONT/CEILING

#### ■ Mounting in the ceiling and projecting from rear

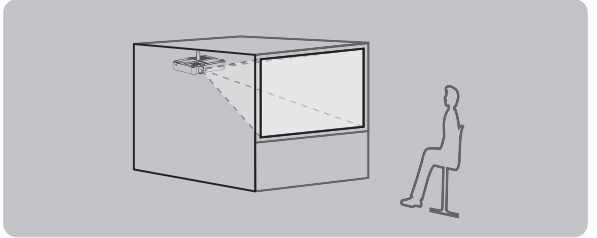

INSTALLATION: REAR/CEILING

#### NOTE:

- A translucent screen is required for rear projection.
- When mounting the projector in the ceiling, the optional ceiling mount bracket (ET-PKB50) is required.



## Front adjustable legs and throwing angle

You can adjust the projection angle in the vertical direction by pressing the **Font leg adjuster** buttons. See "Positioning the image" on page 22.

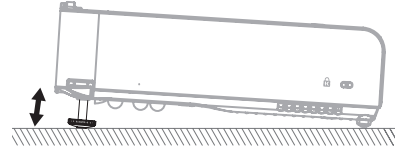
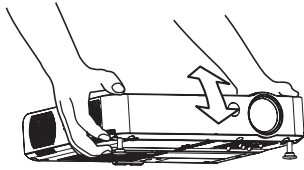
**NOTE:**

- Heated air comes out of the **Air exhaust port**. Be careful of this when adjusting the **Font adjustable legs**.
- If keystone distortion occurs, see "KEYSTONE" on page 32.

# Connections

## Before connection to the projector

- Read and follow the operating and connecting instructions of each peripheral device.
- The peripheral devices must be turned off.
- Use cables that match each peripheral device to be connected.
- If the input signal is affected by signal jitter, the projected image may have poor image quality and timebase correction is effective.
- Confirm the type of video signals. See “List of compatible signals” on page 44.
- Only one audio system circuit is available for each of the **COMPUTER AUDIO IN** and **AUDIO IN L-R** connectors, so if you change the audio input source, you will need to remove and insert the appropriate plugs.
- If the signal cables are disconnected or if the power supply for the computer or video deck is turned off while “**DIGITAL ZOOM**” or “**INDEX-WINDOW**” is being used, these functions will be canceled.  
See “Enlarging the centered area” on page 26.  
See “Projecting an image in INDEX-WINDOW mode” on page 25.

## Connecting with computers

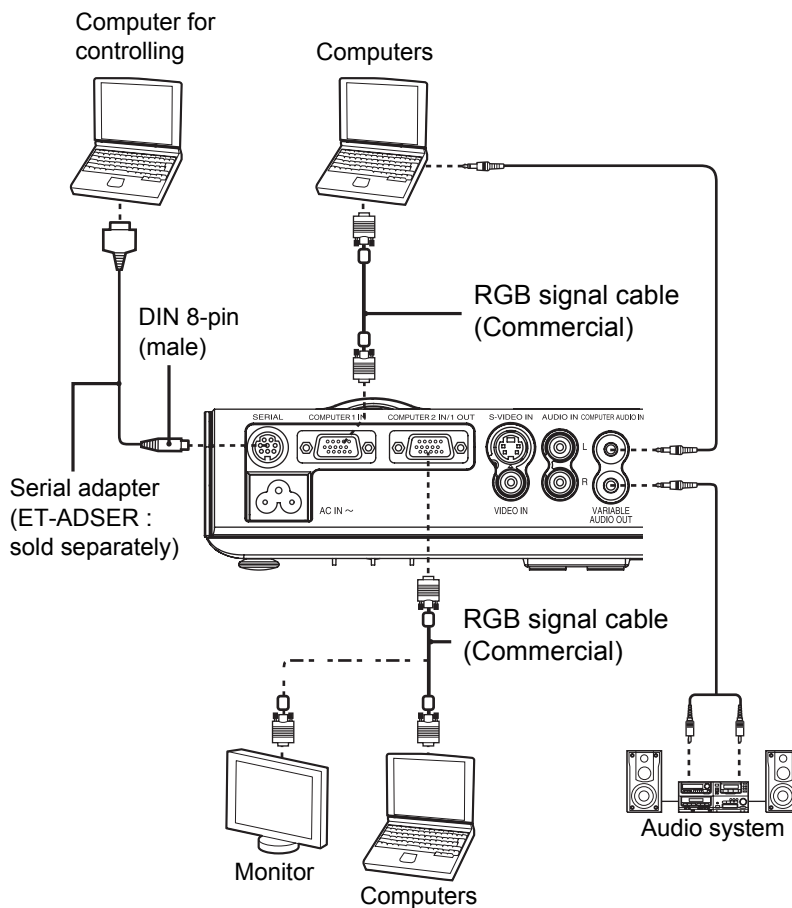

### NOTE:

- When **COMPUTER2 SELECT** in the **OPTION** menu is set to **OUTPUT**, do not connect any input signals.
- Refer to the accessory CD-ROM for details on the wireless network that can be used for controlling the projector with a personal computer. (PT-LB51NTU only)

## Connecting with AV equipment

### Connecting with VIDEO IN/S-VIDEO IN

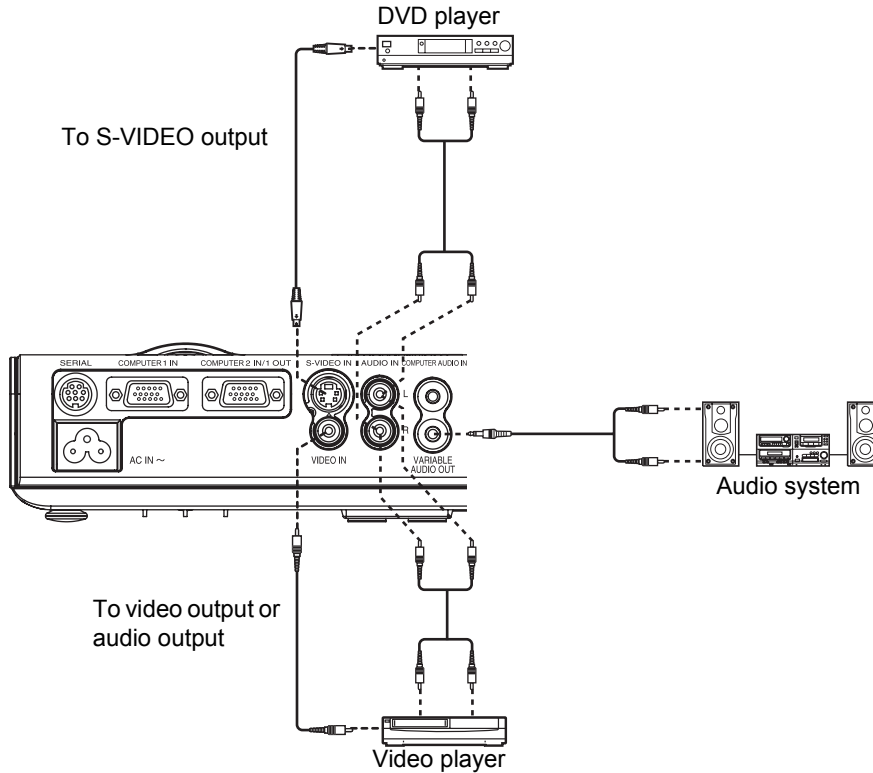

### Connecting with COMPONENT IN

D-sub15-pin (male) - BNCx5 (male) adapter cable  
 Red (connect to PR signal connector)  
 Blue (connect to PB signal connector)  
 Green (connect to Y signal connector)

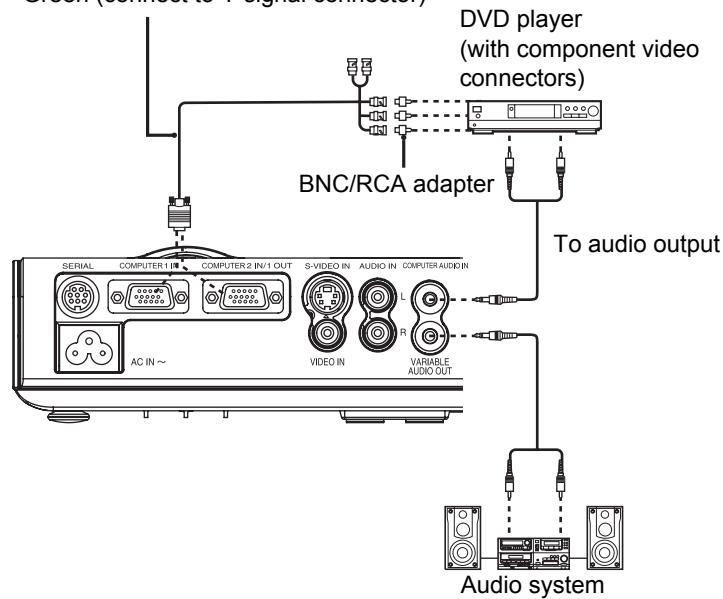

**NOTE:**

- If you connect the BNC cables, use with a commercial BNC-RCA adaptor.

# Switching the projector on/off

## Power cord

### Connecting

1. Make sure the shape of the power cord plug and the **AC IN** connector on the back of the projector match, then push the plug all the way in.
2. Connect the **Power cord** to a wall outlet.

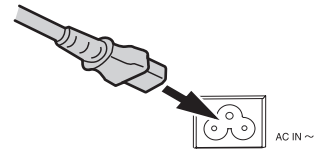

### Disconnecting

1. Check that the **POWER** indicator of the **POWER** button is lit red, and then unplug the **Power cord** from the wall outlet.
2. Hold the plug and unplug the **Power cord** from the **AC IN** connector on the back of the projector.

### Direct power off function

You can disconnect the **Power cord** during projection or immediately after use and move the projector. The cooling fan will operate by the internal power supply to cool down the lamp.

- When this function is used, it may take more time for the lamp to turn back on again compared to when the lamp cools down with the **Power cord** connected.
- Do not put the projector in a bag while the **POWER** button on the projector is illuminated.

### Direct power on function

If you activate the **DIRECT POWER ON**, you can start the projection only with connecting the **Power cord**. See "DIRECT POWER ON" on page 35.

#### NOTE:

- Do not use other than a provided **Power cord**.
- Ensure all the input devices are connected and turned off before connecting the **Power cord**.
- Do not force the connector as this may damage the projector and/or the **Power cord**.
- Dirt or dust build-up around plugs may cause fire or electrical hazards.
- Switch off the power to the projector when not in use.

## POWER indicator

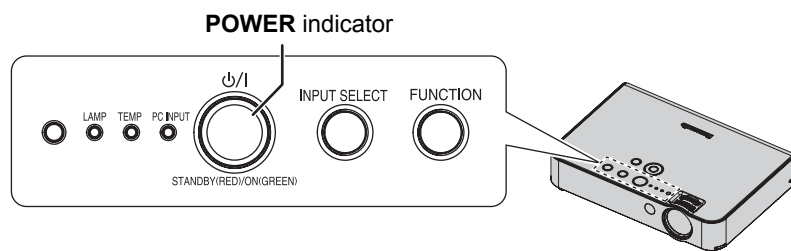

Indicator status		Status
RED	Lit	The projector is in standby. When the <b>LAMP</b> or <b>TEMP</b> indicator is flashing, the <b>POWER</b> indicator will not be lit.
	Flashing	The <b>POWER</b> is switched on and the projector is getting ready to project.
GREEN	Lit	The projector is ready to project.
	Flashing	The <b>POWER</b> is switched off and the projector is cooling the lamp.
ORANGE	Lit	The <b>POWER</b> is switched on again when cooling the lamp and recovering to projection mode. Recovery may take a while.
	Flashing	

#### NOTE:

- If the projector is switched on again while the internal cooling fan is still operating by the internal power supply, it may take a while to start the projection.
- The electric consumption in standby mode is 4 W.

## Switching on the projector

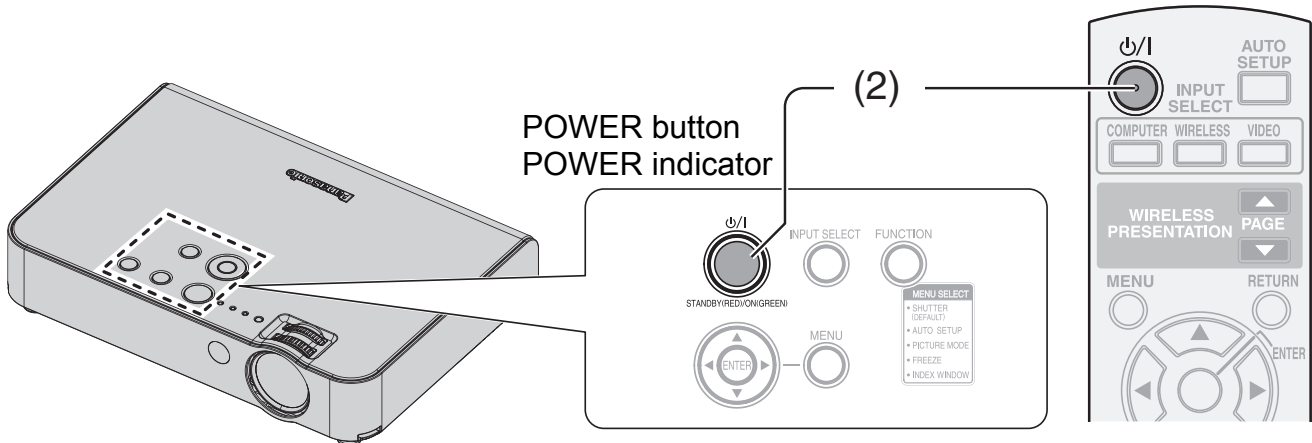

1. Plug the **Power cord** into the projector.
  - The **POWER** indicator lights up in **RED**.
2. Press the **POWER** button.
  - The **POWER** indicator lights up in **GREEN** after flashing for a while.
  - The **STARTUP LOGO** is displayed on the screen. See "STARTUP LOGO" on page 34.

### NOTE:

- Some small rattling or tinkling sound may be heard when starting up, but this is normal and does not affect the performance of the projector.
- If you disconnected the **Power cord** while on projecting mode, the projection will start with connecting the **Power cord**. See "DIRECT POWER ON" on page 35.

## Switching off the projector

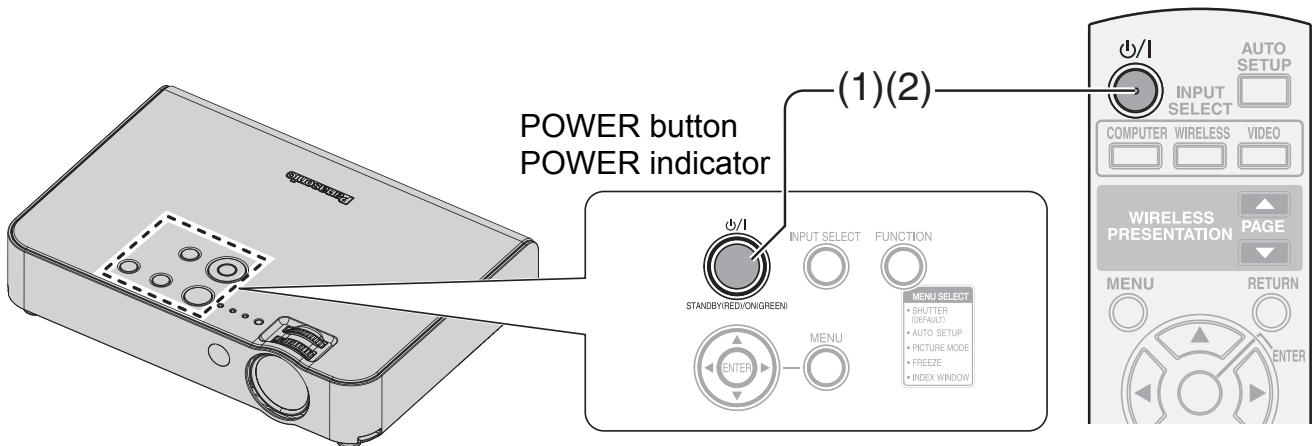

1. Press the **POWER** button.
  - The confirmation screen is displayed. It will disappear and return to the projection after 10 seconds without any operation.
  - To return to the projection, press any button except the **POWER** button.
2. Press the **POWER** button.
  - The **POWER** indicator lights up in **ORANGE** while cooling the lamp, then illuminates **RED**.
3. Once the **POWER** indicator is lit red, unplug the **Power cord** from the projector.
  - If you are in a hurry, you can also use the direct power off function while unplugging the **Power cord** from the projector. (page 20)

### NOTE:

- Press the **POWER** twice or for a long duration to switch the power off.
- You can disconnect the **Power cord** instead of following this procedure. See "DIRECT POWER ON" on page 35.
- You can turn off the projector by pressing the **POWER** button longer than 0.5 seconds.

# Projecting an image

## Selecting the input signal

1. Switch on the connected devices.
  - Press the play button of the required device.
2. Press the **INPUT SELECT** buttons to select the required input method if needed. See “Switching the input signal” on page 24.
  - The image will be projected on the screen.

### NOTE:

- **SIGNAL SEARCH** is **ON** as default and the signal from the connected devices is detected automatically. See “SIGNAL SEARCH” on page 35.
- If no signal is detected, the guide screen for computer connection will be displayed (when “INPUT GUIDE” in the “OPTION” menu is set to “DETAILED”. See “INPUT GUIDE” on page 34.)
- Press the **INPUT SELECT** button to finish the input signal search.

## Positioning the image

Follow the procedure below when you set the projector up first, and when you change the placement after original setup.

1. Adjusting the angle.
  - Place the projector so that it is vertical to the screen.

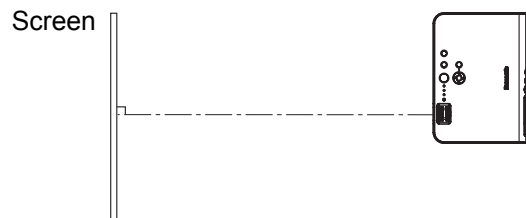

- While pressing the **Front leg adjuster** button, adjust the forward/back angle of tilt of the projector. Adjust so that the projected image is placed at the center of the screen.
- See “Front adjustable legs and throwing angle” on page 17.

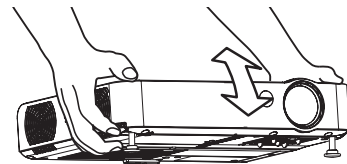

2. Press the **AUTO SETUP** button (when RGB signals are being input).
  - Settings such as the position of the image will be corrected automatically. See “Setting up the image position automatically” on page 23.

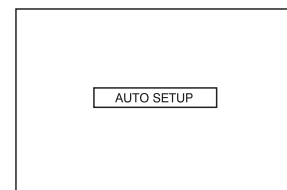

3. Adjusting the size.
  - Turn the **Zoom ring** to adjust the size of the projected image.
4. Adjusting the focus.
  - Turn the **Focus ring** to adjust the focus of the projected image.

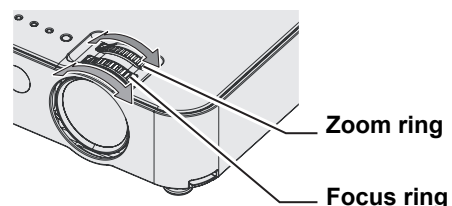

### NOTE:

- Heated air comes out of the **Air exhaust port**. Be careful of this when adjusting the **Font adjustable legs**.
- If keystone distortion occurs, see “KEYSTONE” on page 32.
- If you adjust the focus, you may need to adjust the size of the image by moving the **Zoom ring** again.

# Remote control operation

## Operating range

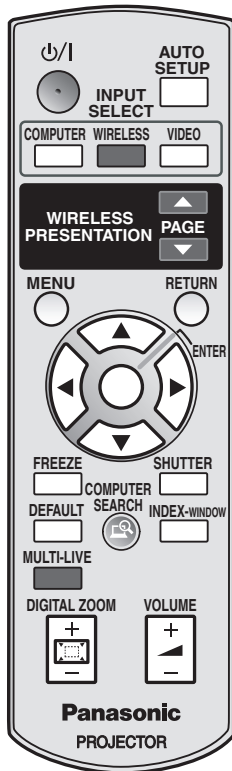

You can operate the projector with the **Remote control** within the remote range 15 m (49'2").

### ● Facing to the projector

Ensure the **Remote control emitter** is facing to the **Remote control signal receptor** on front of the projector and press the required buttons to operate.

### ● Facing to the screen

Ensure the **Remote control emitter** is facing to the screen and press the required buttons to operate the projector. The signal will be reflected off the screen. The operating range may differ due to the screen material. This function may not be effective with a translucent screen.

#### NOTE:

- Do not let strong light shine onto the signal receptor. The **Remote control** may malfunction under strong light such as fluorescent.
- If there are any obstacles between the **Remote control** and the **Remote control signal receptor**, the **Remote control** may not operate correctly.

## Setting up the image position automatically



You can adjust the setting of the image position, **DOT CLOCK** and **CLOCK PHASE** automatically for the projected **COMPUTER** signal image.

#### NOTE:

- **SIGNAL SEARCH** will be adjusted only when the **SIGNAL SEARCH** is set to **ON**.
- If the dot clock frequency is 100 MHz or higher, **AUTO SETUP** is not effective.
- If the projected image is dark or blurred around the edge, **AUTO SETUP** may stop the processing before complete. Project a much clearer or lighter image and press the **AUTO SETUP** button again.
- When **FUNCTION BUTTON** is set to "AUTO SETUP" (see "FUNCTION BUTTON" on page 34), the **AUTO SETUP** operation can also be carried out by pressing the **FUNCTION** button at the front of the projector.

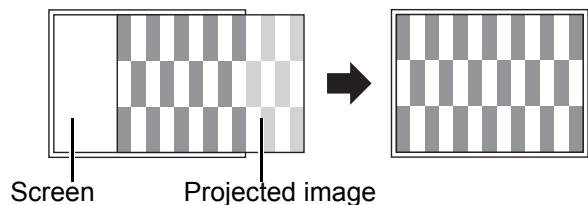

## Remote control operation

### Switching the input signal

COMPUTER



WIRELESS



VIDEO



You can switch the input method manually by pressing the **COMPUTER**, **WIRELESS** (PT-LB51NTU only) and **VIDEO** buttons. Press the required button several times or ◀ ▶ to cycle through the input methods as follows. The actual projected image will be changed in a while.

#### Pressing the COMPUTER button



#### NOTE:

- Only when the **COMPUTER2 SELECT** is set to **INPUT**, you can switch between **COMPUTER1** and **COMPUTER2**.

#### Pressing the WIRELESS button

- The **WIRELESS** button is only for PT-LB51NTU.
- See **CD-ROM** contents for more detailed information.

#### NOTE:

- See "List of compatible signals" on page 44.
- See "Connections" on page 18.

### Capturing an image

FREEZE



When projecting an image, press **FREEZE** to capture the projected image and display it on the screen as a still picture. Press again to escape. While the image is frozen, the sound will be stopped.

#### Pressing the VIDEO button



#### Pressing the INPUT SELECT button on the projector

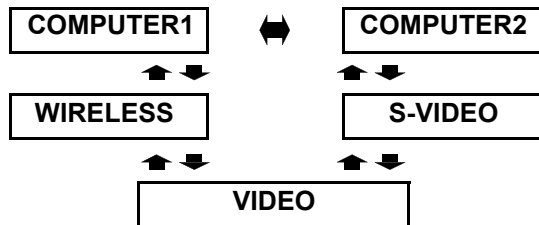

- **WIRELESS** is only for PT-LB51NTU.

#### NOTE:

- Press the **FREEZE** button to return to the projection.
- When **FUNCTION BUTTON** is set to "FREEZE" (see "FUNCTION BUTTON" on page 34), the **FREEZE** operation can also be carried out by pressing the **FUNCTION** button at the front of the projector.

### Stopping the projection temporary

SHUTTER



The "SHUTTER" function can be used to momentarily turn off the picture and sound from the projector when the projector is not being used for short periods of time, such as during breaks in meetings or when carrying out preparation. The projector uses less power in "SHUTTER" mode than it does in normal projection mode.

#### NOTE:

- Escaping from the shutter mode is available by pressing any button.
- This operation can also be carried out using the **SHUTTER** command in the **MAIN MENU**. See "SHUTTER" on page 36.
- When **FUNCTION BUTTON** is set to "SHUTTER" (see "FUNCTION BUTTON" on page 34), the **SHUTTER** operation can also be carried out by pressing the **FUNCTION** button at the front of the projector.



## Resetting to the factory default settings

**DEFAULT**

You can reset most of the customised settings to the factory defaults by pressing **DEFAULT** button of the **Remote control**. Display the required sub menu or the menu items and press the **DEFAULT** button again.

- See "Main menu and Sub-menu" on page 28.

**NOTE:**

- Some menu items are not available to reset by pressing the **DEFAULT** button. Adjust each menu items manually.

## Projecting an image in INDEX-WINDOW mode

**INDEX-WINDOW**

You can project an image in split 2 windows as an **INDEX-WINDOW**, one is frozen, stored in memory and displayed on the screen's left side, while the display of subsequent images continues on the right.

To escape from the **INDEX-WINDOW**, press the **RETURN** button.

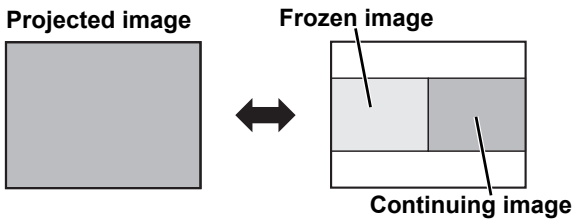

● **Switching the position**

In default, the frozen image is displayed on the left and the subsequent image is displayed on the right. Press ◀ ▶ to switch the position.

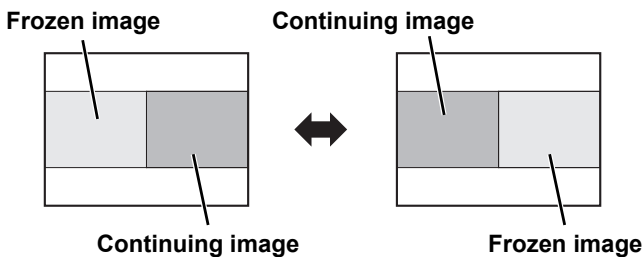

● **Changing the image size**

Press ▲ ▼ to switch and cycle through in 3 size.

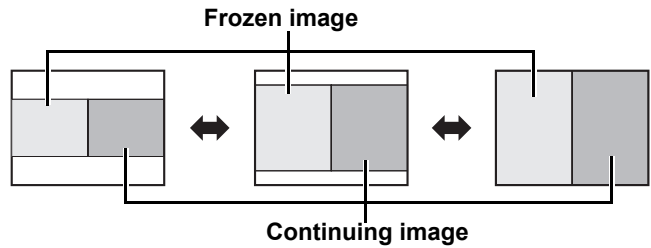

● **Capturing a new image**

While in **INDEX-WINDOW** mode, press **ENTER** to capture a new image and the frozen image window will be updated in a while.

**NOTE:**

- If you change the window size, the aspect ratio of the image is changed and becomes vertically elongated.
- This operation can also be carried out using the **INDEX-WINDOW** command in the **MAIN MENU**. See "INDEX-WINDOW" on page 36.
- When **FUNCTION BUTTON** is set to "INDEX WINDOW" (see "FUNCTION BUTTON" on page 34), the **INDEX-WINDOW** operation can also be carried out by pressing the **FUNCTION** button at the front of the projector.

## Remote control operation

### Enlarging the centered area

#### DIGITAL ZOOM



You can enlarge the projected image down to a centered area for emphasizing within the range of 1x to 2x.

#### ● Enlarging the image

1. Press **DIGITAL ZOOM +/-** button once.
  - The centered area of the image will then be enlarged to 1.5x.

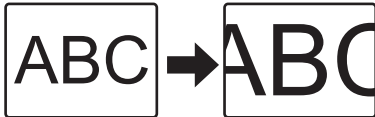

2. Adjust the image size by pressing **DIGITAL ZOOM +/-** button.
  - The image size will be changed in steps of 0.1.



#### ● Shifting the center point

Press **▲ ▼ ◀ ▶** to shift the center point.

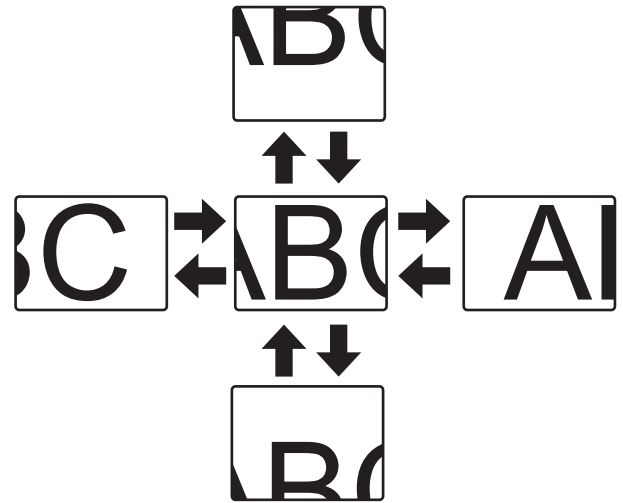

#### NOTE:

- When the **COMPUTER** signal is projected, the enlargement range will be changed to 1x to 3x. When the **FRAME LOCK** in **POSITION** menu is set to **ON**, the enlargement range is 1x to 2x. See "FRAME LOCK" on page 33.
- When the input signal is changed while the **DIGITAL ZOOM** is activated, the **DIGITAL ZOOM** will be canceled.

### Controlling the volume of the speaker

#### VOLUME



You can control the volume of the built-in speakers and output sound. Press +/- to control the volume.

#### NOTE:

- Power consumption can be reduced if the volume level is lowered.
- This operation can also be carried out using the **VOLUME** command in the **MAIN MENU**. See "VOLUME" on page 36.

# Menu Navigation

The menu system allows you to access functions which do not have their own dedicated buttons on the **Remote control**. The menu options are structured and categorised. You can navigate through the menu with ▲ ▼ ► ◀ buttons.

## Navigating through the MENU

### Displaying the Main menu

**MENU** Press the **MENU** button to display the **Main menu** and the operating guidance.

- The illustrations of the on-screen menus in this operating instructions are for the PT-LB51NTU.

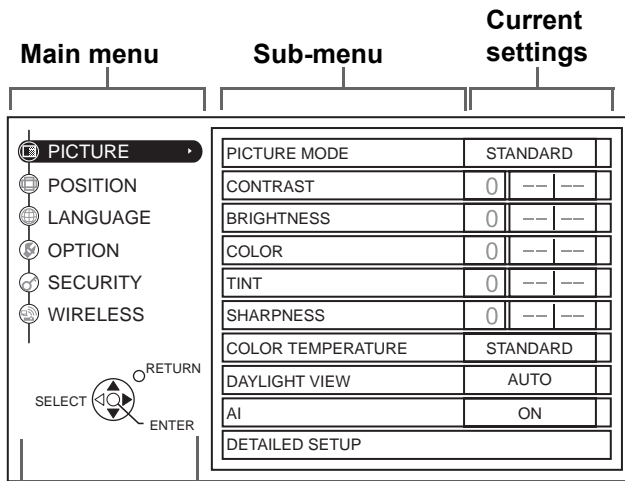

#### Operating guidance

Contains the required buttons to adjust the settings.

### Adjusting with the bar scale items

The triangle mark under the bar indicates factory default setting and the square indicates the current setting.

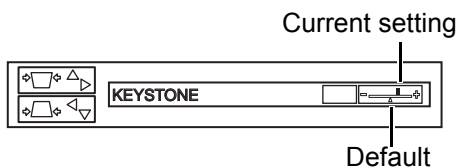

### Returning to the previous menu

**RETURN** Press the **MENU** or **RETURN** button to return to the previous menu. Press repeatedly to escape from the menu mode and return to the projection.

### Operating procedure

- Press ▲ ▼ to scroll to the required **Main menu** item and press **ENTER** to select.
  - The selected item is highlighted in orange and the **Sub-menu** is displayed on the right.
  - See “Main menu and Sub-menu” on page 28.

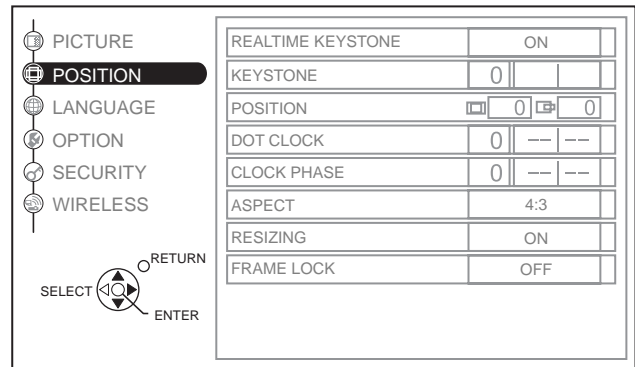

- Press ▲ ▼ to scroll to the required **Sub-menu** item and press ◀ ► or **ENTER** to adjust.
  - The selected item is called up and the other menu items disappear from the screen. Called up item will disappear after 5 seconds and return to the menu mode.
  - If there is a lower level, the next level will be displayed.

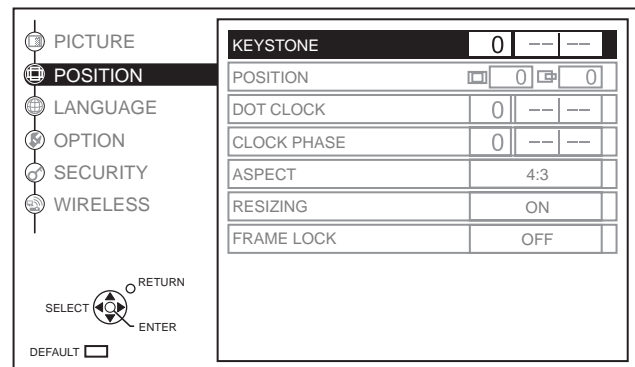

- Press ◀ ► to adjust or set the selected item.
  - For items using a bar scale, the current settings are displayed on the left of the bar scale.
  - You can cycle through the options of an item by pressing ◀ ►.



- Press **MENU** or **RETURN** to return to the previous menu.

#### NOTE:

- See “Resetting to the factory default settings” on page 25 to reset each menu items.



# Menu Navigation

## Main menu and Sub-menu



The **Main menu** has 6 options. Select the required menu item and press **ENTER** to display the **Sub-menu**.

**NOTE:**

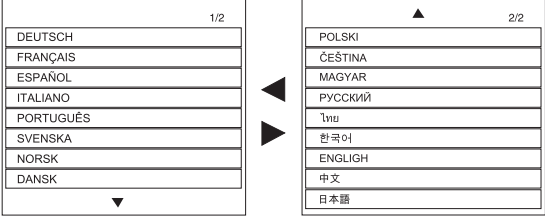
- Some default settings vary by the selected input signal.
- **Sub-menu** items vary according to the selected input signal.
- Some settings are adjustable without any signals.

Main menu	Sub-menu	Options (Under line is default setting)		Page	
<b>PICTURE</b> 	<b>PICTURE MODE</b>	<u>NATURAL</u> <u>STANDARD</u>	<u>DYNAMIC</u> <u>BLACKBOARD</u>	page 30	
	<b>CONTRAST</b>	• Default: 0		page 30	
	<b>BRIGHTNESS</b>	• Default: 0		page 30	
	<b>COLOR<sup>*1</sup></b>	• Default: 0		page 30	
	<b>TINT<sup>*1</sup></b>	• Default: 0		page 30	
	<b>SHARPNESS</b>	• Default: 0		page 30	
	<b>COLOR TEMPERATURE</b>	<u>LOW</u> <u>HIGH</u>	<u>STANDARD</u>	page 30	
	<b>DAYLIGHT VIEW</b>	<u>AUTO</u>	<u>OFF</u>	page 31	
	<b>AI</b>	<u>ON</u>	<u>OFF</u>	page 31	
	<b>DETAILED SETUP<sup>*2</sup></b>	<b>WHITE BALANCE</b> (RGB signals only) • Default: 0	<u>WHITE BALANCE RED</u> <u>WHITE BALANCE GREEN</u> <u>WHITE BALANCE BLUE</u>	page 31	
<b>TV-SYSTEM</b> (S-VIDEO/VIDEO signals only)		<u>AUTO</u> <u>NTSC</u> <u>NTSC 4.43</u> <u>PAL</u> <u>PAL-M</u> <u>PAL-N</u> <u>SECAM</u>			
<b>STILL MODE</b> (S-VIDEO/VIDEO)		<u>OFF</u> <u>ON</u>			
<b>NOISE REDUCTION</b> (S-VIDEO/VIDEO)		<u>ON</u> <u>OFF</u>			
<b>POSITION</b> 	<b>REALTIME KEYSTONE</b>	<u>OFF</u>	<u>ON</u>	page 32	
	<b>KEYSTONE</b>	• Default: 0		page 32	
	<b>POSITION<sup>*3</sup></b>	<u>H</u>	• Default: 0		page 32
		<u>V</u>	• Default: 0		
	<b>DOT CLOCK<sup>*4</sup></b>	• Default: 0		page 32	
	<b>CLOCK PHASE<sup>*4</sup></b>	• Default: 0		page 32	
	<b>ASPECT<sup>*3</sup></b>	<u>4:3</u>	<u>S4:3</u>	page 32	
		<u>16:9</u>	<u>AUTO</u>		
<b>RESIZING</b>	<u>OFF</u>	<u>ON</u>	page 33		
<b>FRAME LOCK<sup>*4</sup></b>	<u>OFF</u>	<u>ON</u>	page 33		
<b>LANGUAGE</b> 			page 33		

\*1. S-VIDEO/VIDEO/COMPONENT signals only  
 \*2. S-VIDEO/VIDEO/COMPUTER signals only  
 \*3. S-VIDEO/VIDEO/COMPUTER/COMPONENT signals only  
 \*4. COMPUTER/COMPONENT signals only

Main menu	Sub-menu	Options (Under line is default setting)		Page	
<b>OPTION</b> 	INPUT GUIDE	<u>DETAILED</u> OFF	SIMPLE	page 34	
	STARTUP LOGO FUNCTION BUTTON	<u>ON</u>	OFF	page 34	
		SHUTTER PICTURE MODE INDEX-WINDOW	AUTO SETUP FREEZE	page 34	
	COMPUTER2 SELECT	<u>INPUT</u>	OUTPUT	page 34	
	LAMP POWER	<u>STANDARD</u>	ECO-MODE	page 34	
	LAMP RUNTIME			page 35	
	POWER OFF TIMER	<u>DISABLE</u>	35 MIN.	60 MIN.	page 35
		15 MIN.	40 MIN.		
		20 MIN.	45 MIN.		
		25 MIN.	50 MIN.		
		30 MIN.	55 MIN.		
	DIRECT POWER ON	<u>OFF</u>	ON	page 35	
	CONTROL PANEL	<u>VALID</u>	INVALID	page 35	
	AUTO SETUP	<u>AUTO</u>	BUTTON	page 35	
	SIGNAL SEARCH	<u>ON</u>	OFF	page 35	
	INSTALLATION	<u>FRONT/DESK</u>	REAR/DESK	page 35	
		FRONT/CEILING	REAR/CEILING		
	HIGHLAND	<u>OFF</u>	ON	page 36	
	RGB/YPBPR	<u>AUTO</u>	RGB	page 36	
YPBPR					
VOLUME	• Default: 20		page 36		
DETAILED SETUP	<u>INDEX WINDOW</u>		page 36		
	SHUTTER				
	OSD DESIGN	TYPE1 TYPE3		TYPE2	
	SXGA MODE	SXGA		SXGA+	
	XGA MODE	XGA		WXGA	
	BLACKBOARD	<u>ON</u>		OFF	
	BACK COLOR	<u>BLUE</u>		BLACK	
<b>SECURITY</b> 	INPUT PASSWORD	<u>OFF</u>	ON	page 37	
	PASSWORD CHANGE			page 37	
	TEXT DISPLAY	<u>OFF</u>	ON	page 37	
	TEXT CHANGE			page 37	
<b>WIRELESS</b>  (PT-LB51NTU only)	NETWORK			page 38	
	NAME CHANGE				
	INPUT PASSWORD				
	PASSWORD CHANGE				
	WEB CONTROL				
	LIVE MODE CUT IN				
	STATUS				
	INITIALIZE	(See CD-ROM contents for detailed information)			

# PICTURE menu

## Remote control

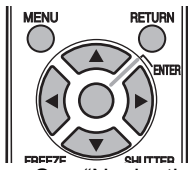

- See "Navigating through the MENU" on page 27.
- See "Main menu and Sub-menu" on page 28.

## Control panel

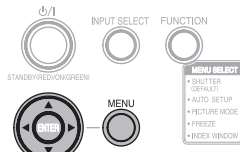

## PICTURE MODE

Depending on the projection environment, you can use these preset parameter settings to optimise image projection. Press ◀ ▶ to cycle through the options.

<b>STANDARD</b>	Setting for a general image
<b>DYNAMIC</b>	Bright and sharp setting
<b>BLACKBOARD</b>	Setting for when projecting on a blackboard See "BLACKBOARD" on page 36.
<b>NATURAL</b>	Reproduces the original color of the image

### NOTE:

- It may take for a while until the selected mode is stabilised.
- When FUNCTION BUTTON is set to "PICTURE MODE" (see "FUNCTION BUTTON" on page 34), the PICTURE MODE operation can also be carried out by pressing the **FUNCTION** button at the front of the projector.

## CONTRAST

You can adjust the contrast of the projected image. Adjust the **BRIGHTNESS** in advance if necessary.



## BRIGHTNESS

You can adjust the brightness of the projected image.



## COLOR

(S-VIDEO/VIDEO/COMPONENT signals only)  
You can adjust the color saturation of the projected image.



## TINT

(NTSC/NTSC 4.43/COMPONENT signals only)  
You can adjust the skin tone in the projected image.



## SHARPNESS

You can adjust the sharpness of the projected image.



## COLOR TEMPERATURE

You can adjust the white balance of the projected image.

- **LOW** More bluish
- **STANDARD** Balanced white
- **HIGH** More reddish

## Projecting sRGBcompatible pictures

sRGB is an international color reproduction standard (IEC61966-2-1) established by the International Electrotechnical Commission (IEC).

If you would like the colors in sRGB-compatible pictures to be reproduced more faithfully, make the following settings.

1. Press the ▲ or ▼ button to select "**PICTURE MODE**", and then press the ◀ or ▶ button to select "**NATURAL**".
2. Press the **DEFAULT** button on the remote control unit.
3. Press the ▲ or ▼ button to select "**COLOR TEMPERATURE**", and then press the ◀ or ▶ button to select "**STANDARD**".

### NOTE:

- sRGB is only enabled when RGB signals are being input (when "**LAMP POWER**" is set to "**STANDARD**", "**AI**" is set to "**OFF**", and "**DAYLIGHT VIEW**" is set to "**OFF**").

## DAYLIGHT VIEW

You can keep the projected image bright and vivid even in well-lit rooms where the ambient light sources cannot be controlled, such as when a door opens or when window coverings fail to block out sunlight.

- **AUTO:** Automatic adjustment
- **OFF:** Deactive

### NOTE:

- Do not cover the Luminance Sensor of the projector. See "Luminance Sensor" on page 12.
- **AUTO** is not available when **INSTALLATION** setting in **OPTION** menu is set to **REAR/DESK** or **REAR/CEILING**.

## AI

The lamp is controlled according to the input signals to project images with the best quality.

- **ON:** Active
- **OFF:** Deactive

### NOTE:

- "AI" is disabled when "LAMP POWER" is set to "ECO-MODE". See "LAMP POWER" on page 34.

## DETAILED SETUP

You can perform more detailed image adjustment manually.

### For RGB signals

#### WHITE BALANCE

You can adjust the white balance more properly in 3 colors temperature by pressing ◀ ▶.

- **WHITE BALANCE RED**
- **WHITE BALANCE GREEN**
- **WHITE BALANCE BLUE**

### For S-VIDEO/VIDEO signals

#### TV-SYSTEM

When the video signal is changed, the setting switches automatically. You can switch the setting manually to match the video data. Press ◀ ▶ to cycle through the options.

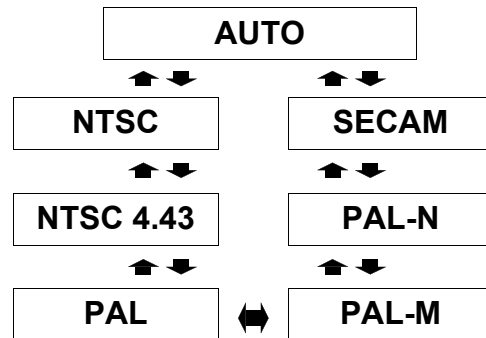

### NOTE:

- **AUTO** setting will select from **NTSC/NTSC 4.43/PAL/PAL60/PAL-M/PAL-N/SECAM**.

#### STILL MODE

You can reduce the vertical flicker when projecting a still image.

- **OFF:** Deactive
- **ON:** Active

### NOTE:

- Set to **OFF** when projecting a moving image.

#### NOISE REDUCTION

You can switch the automatic noise reduction system on/off. Press ◀ ▶ to select the required setting.

- **ON:** Automatic noise reduction
- **OFF:** No noise reduction

### NOTE:

- Applying noise reduction may affect image quality.

# POSITION menu

**Remote control**

- See "Navigating through the MENU" on page 27.
- See "Main menu and Sub-menu" on page 28.

**Control panel**

## POSITION

(S-VIDEO/VIDEO/COMPUTER/COMPONENT signals only)

You can move the projected image for fine adjustment. Press ◀ ▶ to move horizontally and ▲ ▼ vertically.

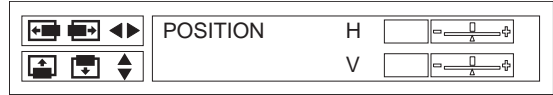

## REALTIME KEYSTONE

This projector detects its own degree of tilt and corrects the keystone distortion automatically.

- **OFF:** Deactive
- **ON:** Active

## KEYSTONE

This projector detects its own degree of tilt and corrects the keystone distortion automatically ("REALTIME KEYSTONE"). However, keystone distortion may still affect the images in some cases (e.g. when the projector is tilted slightly and the tilt is corrected slowly by hand or when the screen itself is tilted). In such cases, set "REALTIME KEYSTONE" to "OFF" and correct the vertical keystone distortion manually.

Image	Operation

### NOTE:

- You can correct the distortion  $\pm 30$  degrees from the plane. For a better quality image, installing the projector with a minimum of distortion is recommended.
- The distortion of the **Main menu** screen is not correctable.
- The result of the keystone correction will affect the aspect ratio and the size of the image.
- You can correct the keystone distortion manually when "REALTIME KEYSTONE" is set to "ON". However, when you turn on the power, the amount of correction will be reset and "REALTIME KEYSTONE" will function again if the tilt is different from the last time you used the projector. If you correct the keystone distortion manually when "REALTIME KEYSTONE" is set to "OFF", the amount of correction will be stored by the projector even after the power is turned off.

## DOT CLOCK

(COMPUTER signals only)

If you have interference patterns of the projected image, which is sometimes referred to as moire or noise, you can minimize it by pressing ◀ ▶ to adjust the clock frequency.

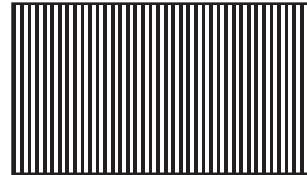

### NOTE:

- If the projecting signal's dot clock frequency is higher than 100 MHz, the adjustment may not make a difference.
- **DOT CLOCK** needs to be adjusted before adjusting the **CLOCK PHASE**.

## CLOCK PHASE

(COMPUTER/COMPONENT signals only)

If you require further adjustment for the same reason as the **DOT CLOCK** adjustment, you can fine adjust the timing of the clock. Press ◀ ▶ to adjust.

### NOTE:

- If the projecting signal's dot clock frequency is higher than 100 MHz, the adjustment may not make a difference.
- **CLOCK PHASE** is available with **PC** signals and the following **COMPONENT** connection.

## ASPECT

(S-VIDEO/VIDEO/480i, 576i, 480p and 576p COMPONENT signals only)

You can switch the aspect ratio manually when needed. Press ◀ ▶ to cycle through the options.

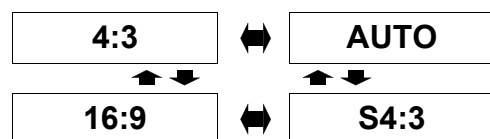



● **4:3**

The input signal will be projected without any change.

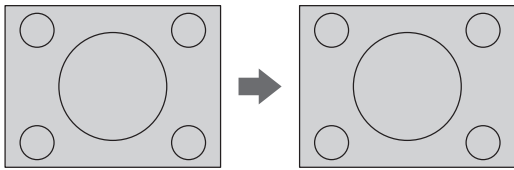

● **16:9**

The squeezed signal will be projected in 16:9 ratio.

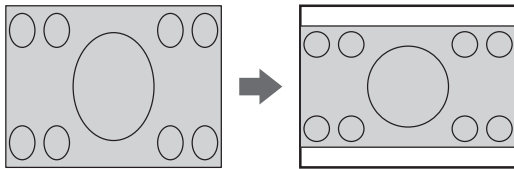

● **S4:3**

The input signal will be sized down 75 % and projected. **S4:3** mode is effective when projecting 4:3 image on to a 16:9 screen.

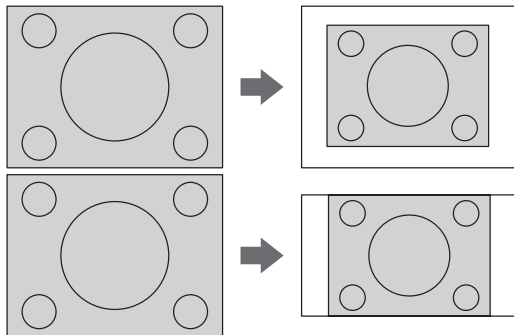

● **AUTO**

The S1 signal which contains an identifying signal will be detected and automatically project the image in proper ratio.

**NOTE:**

- If you project an image with an unmatched aspect ratio, the image may distort or some portions may be cropped. Select an aspect ratio which preserves the intention of the image creator.
- The order of **ASPECT** types is defined not only by the input method but also by the input signals. "List of compatible signals" on page 44
- If you project a copyrighted image enlarged or distorted by using **ASPECT** function in commercial use in a public place, such as a restaurant or hotel, you might infringe on the copyright of the creator which is protected by copyright law.

**S1 video signals**

- S1 video signals are a type of video signal with an aspect ratio of 16:9 which include a detector signal. This detector signal is output by some sources such as wide-vision video decks.
- When "**ASPECT**" is set to "**AUTO**", the projector recognizes the detector signal and automatically switches the aspect ratio to 16:9.

**RESIZING**

(**S-VIDEO/VIDEO/COMPUTER/COMPONENT** signals only)

When the input signal resolution is lower than the projector resolution, it will be projected at the projector resolution. You can deactivate the **RESIZING** and project the lower resolution input signal at its original resolution. Press ◀ ▶ to select the required setting.

- **ON** Active
- **OFF** Deactive

**NOTE:**

- Usually the recommended setting is **ON**.
- When the **RESIZING** is set to **ON**, the lower resolution input signal may be projected in less quality.

**When the RESIZING is set to OFF;**

- The size of the image will be projected smaller and you may need to adjust **ZOOM** and **FOCUS**, or the projector position backward and forward.
- **DIGITAL ZOOM, REALTIME KEYSTONE, KEYSTONE** and **INDEX-WINDOW** are not available.

**FRAME LOCK**

(**COMPUTER** signals only)

If the projected image is degraded, you can activate **FRAME LOCK** for synchronization. Press ◀ ▶ to select the required option.

- **OFF** Deactive
- **ON** Active

**LANGUAGE menu**

1. Press the **MENU** button to display the menu screen.
  - Indicates the language which is currently set
2. Select the "LANGUAGE" menu from the main menu, and then press the **ENTER** button.
3. Press the ▲ or ▼ button to select a language, and then press the **ENTER** button.

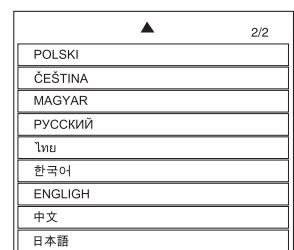
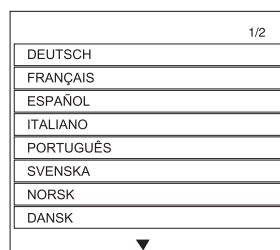

# OPTION menu

**Remote control**

**Control panel**

- See “Navigating through the MENU” on page 27.
- See “Main menu and Sub-menu” on page 28.

## INPUT GUIDE

When the input signal is changed, the input signal information will be displayed in the upper right corner of the projected images. You can select the level of the input signal information.

Options	Function
OFF	The input signal information will not be displayed.
SIMPLE	Only the name of the input signal will be displayed.
DETAILED	The input signal information will be displayed in detail.

**NOTE:**

- If “INPUT GUIDE” is set to “DETAILED”, the guide screen for computer connection will be displayed when **COMPUTER1** or **COMPUTER2** is selected and no signal is being input to the **COMPUTER1 IN** or **COMPUTER2 IN** connector. If you would like the guide screen not to be displayed, set “INPUT GUIDE” to “SIMPLE” or “OFF”.

## STARTUP LOGO

You can switch the logo on/off that is displayed when starting up the projector. Press ◀ ▶ to select the required option.

- ON                      Active
- OFF                    Deactive

## FUNCTION BUTTON

You can assign frequently-used operations to the **FUNCTION** button on the projector and use it as a convenient shortcut button. The functions which can be set are “SHUTTER”, “AUTO SETUP”, “PICTURE MODE”, “FREEZE” and “INDEX WINDOW”.

Use ◀ ▶ to select the function to assign to the **FUNCTION** button.

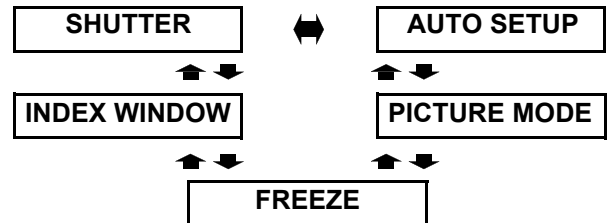

<b>SHUTTER</b>	Operates the shutter function See “SHUTTER” on page 36
<b>AUTO SETUP</b>	Starts the automatic position correction function See “AUTO SETUP” on page 35
<b>PICTURE MODE</b>	Switches the picture mode See “PICTURE MODE” on page 30.
<b>FREEZE</b>	Operates the freeze function See “Capturing an image” on page 24
<b>INDEX WINDOW</b>	Operates the INDEX-WINDOW function See “INDEX-WINDOW” on page 36

## COMPUTER2 SELECT

You can switch the function of the **COMPUTER2 IN/1 OUT** terminal.

- INPUT
- COMPUTER2 IN
- OUTPUT
- COMPUTER1 OUT

## LAMP POWER

This setting changes the lamp brightness. When set to “**ECO-MODE**”, the luminance of the lamp is reduced, but the projector uses less power, and the operating noise is also reduced. This can help to extend the lamp’s operating life. If using the projector in small rooms where high luminance is not required, it is recommended that you set the “**LAMP POWER**” to “**ECO-MODE**”.

- **STANDARD**    Normal mode
- **ECO-MODE**    ECO mode

**NOTE:**

- “**LAMP POWER**” cannot be set when no signal is being input.

## LAMP RUNTIME

You can check how long the lamp has been used.

**NOTE:**

- **LAMP RUNTIME** is a relevant matter for lamp replacement timing. See “Replacing the Lamp unit” on page 41.

## POWER OFF TIMER

You can set the off timer to switch off the **POWER** of the projector after a certain period of time automatically when no signal is detected. Press ◀ ▶ to select the required period from 15 to 60 minutes at intervals of 5 minutes.

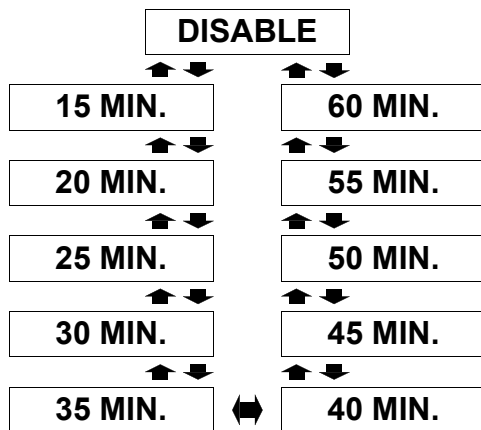

## DIRECT POWER ON

You can switch the projector start up status for when the **Power cord** is connected. Press ◀ ▶ to select the required option.

- **OFF** The projector will start from the standby mode or the projecting mode.  
(The projector will start from the same status as when the power cord was disconnected.)
- **ON** The projector will start from the projecting mode.

**NOTE:**

- When the projector is started from the projecting mode, pressing the **POWER** button procedure is skippable.

## CONTROL PANEL

You can turn off the function of the control panel buttons on the projector body. Press ◀ ▶ to select the required option.

- **INVALID** Invalidate the control panel buttons  
Confirmation screen will be displayed.
- **VALID** Validate the control panel buttons

## AUTO SETUP

You can turn off the **AUTO SETUP** function for when the **COMPUTER** signal is detected.

- **AUTO** When the projector detect a **COMPUTER** signal, adjust the projected image position automatically for **SIGNAL SEARCH**, **DOT CLOCK** and **CLOCK PHASE**.
- **BUTTON** Only when the **AUTO SETUP** button is pressed, the projected image position will be adjusted for **DOT CLOCK** and **CLOCK PHASE**. See “Remote control” on page 10.

**NOTE:**

- Usually the recommended setting is **AUTO**.

## SIGNAL SEARCH

You can turn off the auto signal detecting system.

- **ON** Detect the input signal from the terminals and project the image.
- **OFF** Deactive

**NOTE:**

- **SIGNAL SEARCH** is not available when any input signal is projecting.
- Usually the recommended setting is **ON**.

## INSTALLATION

When installing the projector, select the projection method according to the projector position. Press ◀ ▶ to cycle through the options. See “Projection method” on page 16.

<b>FRONT/DESK</b>	Setting on a desk/floor and projecting from front
<b>FRONT/CEILING</b>	Mounting in the ceiling and projecting from front
<b>REAR/DESK</b>	Setting on a desk/floor and projecting from rear
<b>REAR/CEILING</b>	Mounting in the ceiling and projecting from rear

## OPTION menu

### HIGHLAND

If you use the projector at high elevation, the **HIGHLAND** setting need to be **ON** to set the fan speed high. Press ◀ ▶ to select the required option.

- **OFF** The fan speed is low.
- **ON** The fan speed is high.

#### NOTE:

- At 1 400 m (4 593 ft) above sea level, the setting must be **ON**.
- The loudness of fan noise depends on the **HIGHLAND** setting.

### RGB/YPbPr

(480i, 576i, 480p, 576p, 1 080/60i, 1 080/50i, 720/60p and **VGA480** signals only)

This sets the signal that is input to the **COMPUTER1 IN** and **COMPUTER2 IN/1 OUT** connector.

Normally "**AUTO**" should be selected. **RGB** or **YPbPr** is selected automatically depending on the synchronizing signal status.

If an image is not projected correctly, select "**RGB**" or "**YPbPr**" in accordance with the input signal.

- **AUTO** automatically
- **RGB** RGB
- **YPbPr** YPbPr

### VOLUME

You can adjust the volume of the sound that is output from the projector's built-in speaker and **VARIABLE AUDIO OUT** connector.

### DETAILED SETUP

You can perform more detailed setting in various items.

#### INDEX-WINDOW

This functions in the same way as the **INDEX-WINDOW** button on the remote control unit. Refer to "Projecting an image in INDEX-WINDOW mode" on page 25 for details.

#### SHUTTER

This functions in the same way as the **SHUTTER** button on the remote control unit.

Refer to "Stopping the projection temporary" on page 24 for details.

#### OSD DESIGN

You can change the background color of the menu. Press ◀ ▶ to select the required option.

TYPE1	Semi transparent black
TYPE2	Solid blue
TYPE3	Semi transparent dark blue

#### SXGA MODE

(**COMPUTER SXGA** signals only)

You can switch the setting between **SXGA** and the larger setting, **SXGA+**. Press ◀ ▶ to select the required option.

#### XGA MODE

(**COMPUTER XGA** signals only)

You can switch the setting between **XGA** and the wider setting, **WXGA**. Press ◀ ▶ to select the required option.

#### BLACKBOARD

You can exclude the **BLACKBOARD** in menu items of **PICTURE MODE** in **PICTURE** menu.

Press ◀ ▶ to select the required option.

- **ON** Include the **BLACKBOARD** in menu items.
- **OFF** Exclude the **BLACKBOARD** in menu items.

#### BACK COLOR

You can choose a **BLUE** or **BLACK** screen for when the projector is idle. Press ◀ ▶ to select the required option.

# SECURITY menu

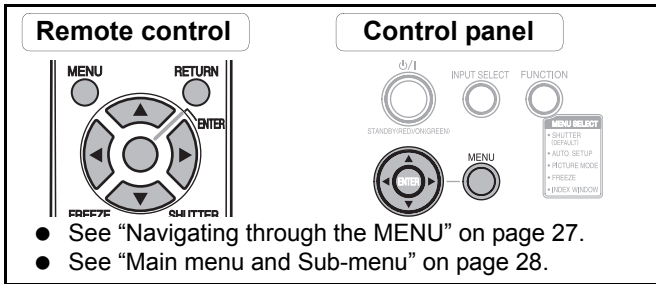

- See "Navigating through the MENU" on page 27.
- See "Main menu and Sub-menu" on page 28.

## Entering the SECURITY

Every time when you apply to the **SECURITY** menu, you will be asked to perform the password operation.

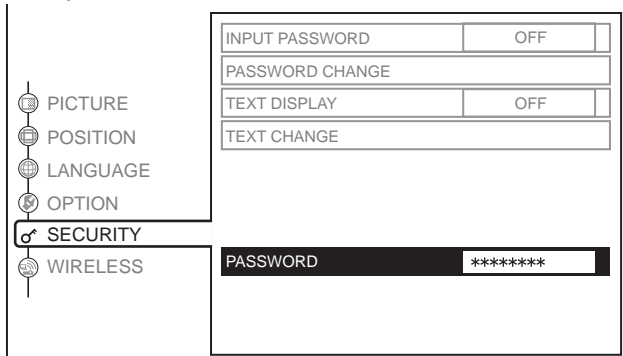

When you apply to the **SECURITY** menu before you change the password to your original, perform to input the following factory default password operation.

- Press ▲▶▼◀▲▶▼◀ and **ENTER**.

## After you change the password

When you apply to the **SECURITY** menu after you change the password to your original in the **PASSWORD CHANGE** menu, input the original password operation.

### NOTE:

- The factory default password is valid until you change the password in **PASSWORD CHANGE** menu.
- The entered password operations will appear as asterisks in the box.

## INPUT PASSWORD

You can activate the security system and the password operation will be asked to perform when the projecting mode started. Unless you perform the correct password operation, all of the button controls will be disabled except the **POWER** button.

- **OFF** Deactive
- **ON** Active

### NOTE:

- When you activated the security system, make sure to change the password to your original for safety.
- The factory default password is valid until you change the password in **PASSWORD CHANGE** menu.

## PASSWORD CHANGE

You can change the password operation to your original.

1. Press a series of button operation up to 8 as a password by using ▲ ▼ ◀ ▶ and **ENTER**.
2. Press **ENTER**.
3. Press the exact same series of button operation you entered in the **NEW** password box for confirmation.
  - If a series of button operation is incorrect, you will be asked to perform again.
4. Press **ENTER**.

### NOTE:

- The entered password operations will appear as asterisks in the box.

## TEXT DISPLAY

You can set your original text, such as company name or URL information, to display regularly at the bottom of the projected image while projecting.

- **OFF** Deactive
- **ON** Active

## TEXT CHANGE

You can enter your original text up to 22 characters for **TEXT DISPLAY**.

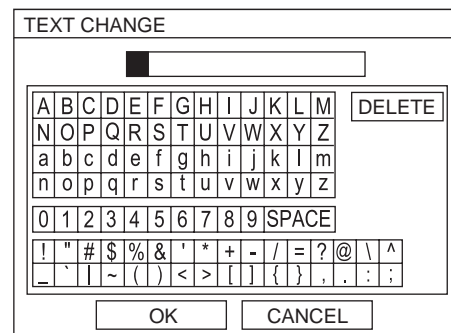

1. Use ▲ ▼ ◀ ▶ to specify the location of the required character.
2. Press **ENTER**.
  - The selected character will be displayed in the **TEXT CHANGE** box.
3. Repeat until finish your original text.
  - If you select **DELETE**, you can delete a character is selected with cursor. Then press **ENTER**.
4. Select **OK** and press **ENTER** to set the entered text.
  - Select **CANCEL** or press **MENU/RETURN** buttons to return to the previous menu.

# WIRELESS menu (PT-LB51NTU only)

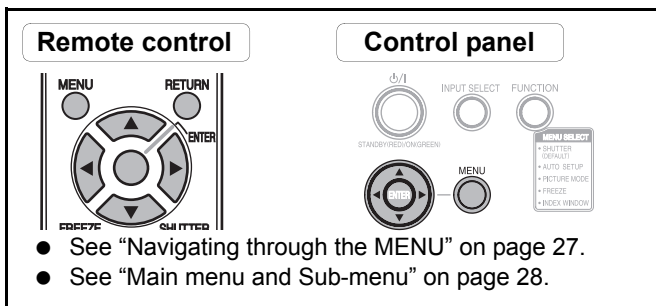

## NOTE:

- See more detailed instructions in the contents of the **CD-ROM** which is provided with the projector.

## Items in WIRELESS menu

In **WIRELESS** menu, the following items are available.

- **NETWORK**  
Select the network setting you want to use.
- **NAME CHANGE**  
The name for this projector can be set.
- **INPUT PASSWORD**  
Set to "ON" if you want password confirmation to be used when controlling the projector with a personal computer by means of the wireless network.
- **PASSWORD CHANGE**  
Passwords can be changed.
- **WEB CONTROL**  
To control the projector with a personal computer by means of the wireless network, set the "WEBCONTROL" to "ON".
- **LIVE MODE CUT IN**  
Set to "ON" to allow users to connect to the network in LIVE mode while another user is already connected in LIVE mode.
- **STATUS**  
The wireless settings will be displayed.
- **INITIALIZE**  
Wireless settings can be returned to the factory default settings.

# TEMP, LAMP Indicators

## Managing the indicated problems

If a problem should occur with the projector, the **TEMP**, **LAMP** indicators will inform you. Manage the indicated problems as follow.

1. Confirm the status of all indicators and projector, and switch off the projector in proper way.
2. Find out the cause of the problem by status of the **TEMP**, **LAMP** indicators.
3. Follow the instruction for each indication below and solve the problem.
4. Turn on the projector in the correct way and confirm the indicator is not indicating a problem any longer.

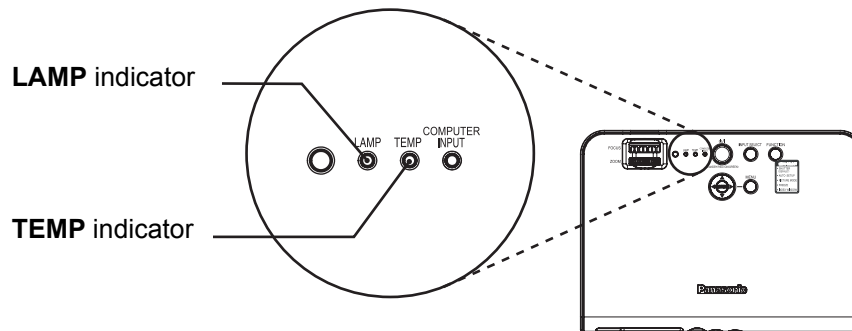

### NOTE:

- If no problem is found or the problem remains, do not turn on the projector. Instead contact an Authorised Service Center.

### LAMP indicator

Indicator	● Illuminating RED	● Flashing RED		
Problem	<b>LAMP RUNTIME</b> has reached 1 800 hours.	<b>LAMP</b> circuit failure, abnormal function or <b>Lamp unit</b> is damaged.		
Cause	<b>Lamp unit</b> will run out soon and needs to be replaced.	The <b>POWER</b> is switched on again before the <b>Lamp unit</b> is cooled enough.	<b>LAMP</b> circuit failure, abnormal function.	<b>Lamp unit</b> is damaged.
Remedy	See "Replacing the Lamp unit" on page 41.	Let the <b>Lamp unit</b> cool down and turn on the <b>POWER</b> .	Contact an Authorised Service Center.	See "Replacing the Lamp unit" on page 41.

### TEMP indicator

Indicator	● Illuminating RED and still projecting ● Flashing RED and <b>POWER</b> is turned off		
Problem	The temperature inside and/or outside the projector is abnormally high.		
Cause	The ventilation openings are covered.	The room temperature is too high.	The projector is located at high elevations (above 1 400 m).
Remedy	Remove the object(s) from the ventilation openings or clear around the projector.	Reinstall the t a temperature controlled place. See "Specifications" on page 48.	Turn on the projector* <sup>1</sup> and set the <b>HIGHLAND</b> to <b>ON</b> . See "HIGHLAND" on page 36.

\*1. The projector will perform only 2 minutes with **OFF** setting at high elevation.

# Care and Replacement

## Cleaning the projector

### Before cleaning the projector

- Disconnect the power cord plug from the wall outlet.
- Unplug all the cables from the projector.

### Cleaning the outer surface of the projector

Wipe off dirt and dust gently with a soft cloth.

- If it is difficult to remove the dirt, soak a cloth in a neutral detergent diluted with water, wring the cloth well and then wipe the projector. Dry off the projector with dry cloth.
- If you use a chemical treated wipe, follow the instructions supplied with it.

### Cleaning the lens

Wipe off dirt and dust gently with a lint-free cloth.

- Make sure no dirt or dust remains on the surface of the lens. It will be enlarged and projected onto a screen.

### Cleaning the air filter

If the air filter becomes clogged with dust, the internal temperature of the projector will rise, the **TEMP** indicator will illuminate and the projector's power will turn off (the **TEMP** indicator will flash after the power is turned off). **The air filter should be cleaned every 100 hours of use.**

**Use a vacuum cleaner to clean off any accumulated dust.**

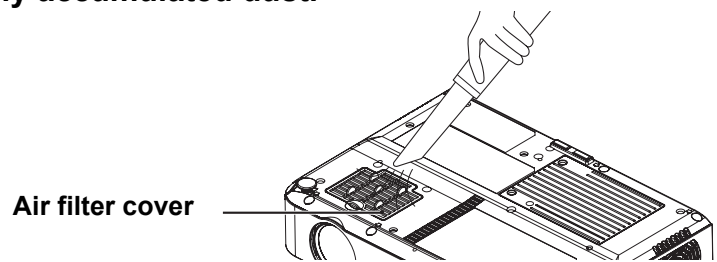

#### NOTE:

- If the dust cannot be cleaned by a vacuum cleaner, remove the air filter and soak it in water, and then wash out the dust by hand. Be sure to install the air filter after it has dried.
- Do not use detergent when washing the air filter.
- If the dust cannot be removed by cleaning, it is time to replace the air filter. Please consult your dealer. Furthermore, if the lamp unit is being replaced, replace the air filter at this time also.

## Replacing the air filter

### Before replacing the Air filter

- Disconnect the power cord plug from the wall outlet.

### Replacement procedure

1. Gently turn the projector upside down.
2. Remove the **Air filter cover**.
3. Replace the **Air filter**, and then install the **Air filter cover**.

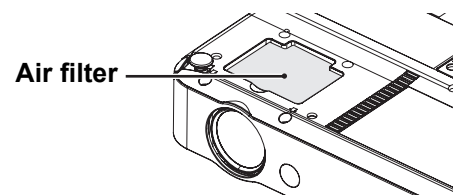
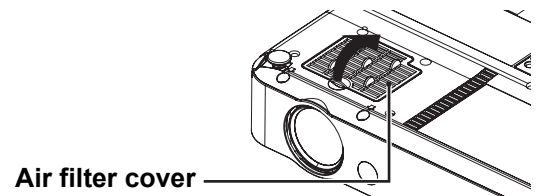

#### NOTE:

- Be sure to install the air filter before using the projector. If the projector is used without the air filter installed, dust and other foreign particles will be drawn into the projector, and malfunctions will result.



## Replacing the Lamp unit

### Before replacing the Lamp unit

- Disconnect the power cord plug from the wall outlet.
- Make sure the **Lamp unit** and the surroundings are cooled enough.
- Prepare a Phillips-head screwdriver.
- Contact an Authorised Service Center to purchase a replacement **Lamp unit** (ET-LAB50).
- When the projector is mounted in the ceiling, do not work directly under the projector or put your face closer to the projector.

**NOTE:**



- Prior to replacing the lamp unit, allow it to cool down to prevent the risk of burns, damage and other hazards.
- Do not attempt replacement with an unauthorised lamp unit.

### When to replace the Lamp unit

The **Lamp unit** is a consumable product. Even when the full life of the bulb has not been exhausted, the brightness of the light will gradually decline. Therefore periodic replacement of the lamp is necessary. The intended lamp replacement interval is 2 000 hours, but it is possible that the lamp may need to be replaced earlier due to variables such as a particular lamp’s characteristics, usage conditions and the installation environment.

Early preparation for lamp replacement is encouraged.

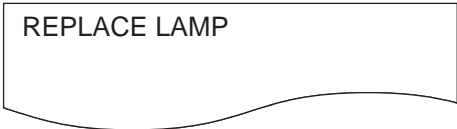
The lamp will automatically shut off after approximately 10 minutes when 2 000 hours of use have been reached because of a much greater chance of it exploding after this time.

Indication	On screen	LAMP indicator
Over 1 800 hours		
Over 2 000 hours	<p>“REPLACEMENT LAMP” is displayed on the upper left of the screen, and it will stay until you respond. To clear the screen, press any button.</p>	Illuminates <b>RED</b> .

**NOTE:**

- The usage hours explained above are for when “**LAMP POWER**” in the “**OPTION**” menu has been set to “**STANDARD**” and when “**AI**” in the “**PICTURE**” menu has been set to “**OFF**”. If “**LAMP POWER**” is set to “**ECO-MODE**”, or “**AI**” is set to “**ON**”, the life of the lamp can be extended.
- While 2 000 hours is the intended replacement interval, it is not a period of time covered by warranty.

### Replacement procedure

**NOTE:**

- If the lamp usage time has passed 2 000 hours (when “**LAMP POWER**” has been set to “**STANDARD**” and when “**AI**” has been set to “**OFF**”), the projector will switch to standby mode after approximately 10 minutes of operation. The steps 7 to 12 should thus be completed within 10 minutes.

1. Disconnect the **Power cord** from the projector (See “Power cord” on page 20), and check that the area around the **Lamp unit** has cooled down.

## Care and Replacement

2. Use a Phillips screwdriver to turn the **lamp unit cover fixing screws** at the bottom of the projector, and then remove the **Lamp unit cover**.

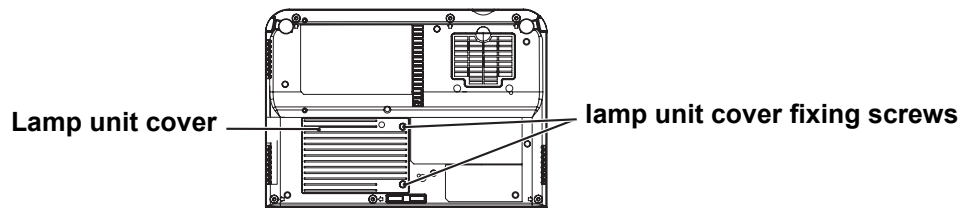

3. Use a Phillips screwdriver to loosen the two **lamp unit cover fixing screws** until the screws turn freely. Then hold the handles of the **Lamp unit** and gently pull the **Lamp unit** out from the projector.

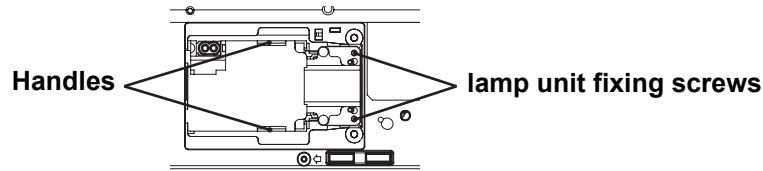

4. Insert the new **Lamp unit** while making sure that the direction of insertion is correct, and then use a Phillips screwdriver to securely tighten the **lamp unit fixing screws**.

- When inserting the new **Lamp unit**, be sure to push it in at the point (A) and (B).

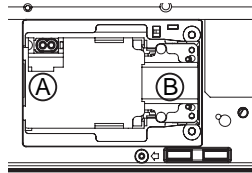

5. Install the **Lamp unit cover**, and then use a Phillips screwdriver to securely tighten the **lamp unit cover fixing screws**.

### NOTE:

- Be sure to install the **Lamp unit** and the **Lamp unit cover** securely. If they are not securely installed, it may cause the protection circuit to operate so that the power cannot be turned on.

6. Connect the **Power cord**.
7. Press the **POWER** button so that a picture is projected onto the screen.

### NOTE:

- If "**DIRECT POWER ON**" in the "**OPTION**" menu has been set to "**ON**", projection will start after the **Power cord** is connected. See "**DIRECT POWER ON**" on page 35.

8. Press the **MENU** button to display the menu screen, and then press the **▲** or **▼** button to select the "**OPTION**" menu.

9. Press the **ENTER** button, and then press the **▲** or **▼** button to select "**LAMP RUNTIME**".

10. Press and hold the **ENTER** button for approximately 3 seconds.

- The "**LAMP RUNTIME**" screen will be displayed.

### NOTE:

- Press any button other than the **POWER** button to cancel the "**LAMP RUNTIME**" screen.

11. Press the **POWER** button to turn off the power.

12. Disconnect the **Power cord** after the **POWER** button on the projector illuminates red.

- This will reset the cumulative usage time for the lamp unit to "0".

# Troubleshooting

Should any problem persist, contact your dealer.

Problem	Cause	Reference page
<b>Power does not turn on.</b>	● The <b>Power cord</b> may not be connected.	20
	● No electric supply is at the wall outlet.	20
	● <b>TEMP</b> indicator is lit or flashes.	39
	● <b>LAMP</b> indicator is lit or flashes.	39
	● The lamp unit cover has not been securely installed.	41
	● The circuit breakers have tripped.	-
<b>No picture appears.</b>	● The video signal input source may not be connected to a terminal properly.	19
	● The input selection setting may not be correct.	24
	● The <b>BRIGHTNESS</b> adjustment setting may be at the minimum setting.	30
	● The signal input source may not be operating properly.	-
	● The <b>SHUTTER</b> function may be in use.	24
<b>The picture is fuzzy.</b>	● The lens focus may not have been set correctly.	22
	● The projector may not be at the correct distance from the screen.	14
	● The lens may be dirty.	40
	● The projector may be tilted too much.	22
<b>The color is pale or greyish.</b>	● <b>COLOR</b> or <b>TINT</b> adjustment may be incorrect.	30
	● The input source which is connected to the projector may not be adjusted correctly.	28
<b>No sound can be heard from the internal speaker.</b>	● The audio signal source may not be connected properly.	18
	● A cable may be connected to the <b>VARIABLE AUDIO OUT</b> terminal.	13
	● The volume adjustment may be at the lowest possible setting.	26
<b>The control buttons of the projector do not operate.</b>	● <b>CONTROL PANEL</b> in <b>OPTION</b> menu is invalidated. If you have a loss of the <b>Remote control</b> while the <b>CONTROL PANEL</b> is invalidated, press and hold the <b>MENU</b> button for 2 seconds with pressing the <b>ENTER</b> button.	35
<b>The Remote control does not operate.</b>	● The batteries may be weak.	-
	● The batteries may not have been inserted correctly.	10
	● The <b>Remote control</b> signal receptor on the projector may be obstructed.	23
	● The <b>Remote control</b> unit may be out of the operation range.	23
	● The <b>Remote control</b> is under the strong light such as fluorescent.	23
<b>The picture does not display correctly.</b>	● The signal format ( <b>TV-SYSTEM</b> ) may not have been set correctly.	31
	● There may be a problem with the VCR or other signal source.	-
	● A signal which is not compatible with the projector is being input.	44
<b>Picture from a computer does not appear.</b>	● The cable may be longer than the optional cable.	-
	● The external video output from a laptop computer may not be correct. (You may be able to change the external output settings by pressing the [Fn] + [F3] or [Fn] + [F10] keys simultaneously. The actual method varies depending on the type of computer; refer to the documentation provided with your computer for further details.)	47
	● If an <b>COMPUTER INPUT</b> indicator is turned off, the video signals may not be output from the computer.	12
	● <b>COMPUTER2 SELECT</b> setting in <b>OPTION</b> menu is not correct.	34

# Technical Information

## List of compatible signals

Mode	Display resolution (dots) <sup>*1</sup>	Scanning frequency		Dot clock frequency (MHz)	Picture quality <sup>*2</sup>	Resizing <sup>*3</sup>	Terminals <signals>
		H (kHz)	V (kHz)				
NTSC/NTSC 4.43/ PAL-M/PAL60	720 x 480i	15.7	59.9		A	OK	VIDEO IN/ S-VIDEO IN <VIDEO/S-VIDEO signals>
PAL/PAL-N/SECAM	720 x 576i	15.6	50.0		A	OK	
480i	720 x 480i	15.7	59.9	13.5	A	OK	COMPUTER1 IN/ COMPUTER2 IN <COMPUTER/ COMPONENT signals>
576i	720 x 576i	15.6	50.0	13.5	A	OK	
480p	720 x 483	31.5	59.9	27.0	A	OK	
576p	720 x 576	31.3	50.0	27.0	A	OK	
1 080/60i	1 920 x 1 080i	33.8	60.0	74.3	A		
1 080/50i	1 920 x 1 080i	28.1	50.0	74.3	A		
720/60p	1 280 x 720	45.0	60.0	74.3	A		
VGA400	640 x 400	31.5	70.1	25.2	A	OK	
*4	640 x 400	37.9	85.1	31.5	A	OK	
VGA480	640 x 480	31.5	59.9	25.2	A	OK	
	640 x 480	35.0	66.7	30.2	A	OK	COMPUTER1 IN/ COMPUTER2 IN <COMPUTER signals>
	640 x 480	37.9	72.8	31.5	A	OK	
	640 x 480	37.5	75.0	31.5	A	OK	
	640 x 480	43.3	85.0	36.0	A	OK	
SVGA *4	800 x 600	35.2	56.3	36.0	A	OK	
	800 x 600	37.9	60.3	40.0	A	OK	
	800 x 600	48.1	72.2	50.0	A	OK	
	800 x 600	46.9	75.0	49.5	A	OK	
	800 x 600	53.7	85.1	56.3	A	OK	
MAC16 *4	832 x 624	49.7	74.6	57.3	A	OK	
XGA	1 024 x 768	48.4	60.0	65.0	AA		
	1 024 x 768	56.5	70.1	75.0	AA		
	1 024 x 768	60.0	75.0	78.8	AA		
	1 024 x 768	68.7	85.0	94.5	AA		
	1 024 x 768i	35.5	87.0	44.9	AA		
MXGA	1 152 x 864	64.0	71.2	94.2	A		
	1 152 x 864	67.5	74.9	108.0	B		
	1 152 x 864	76.7	85.0	121.5	B		
MAC21 *4	1 152 x 870	68.7	75.1	100	B		
MSXGA *4	1 280 x 960	60.0	60.0	108.0	B		
SXGA	1 280 x 1 024	64.0	60.0	108.0	B		
	1 280 x 1 024	80.0	75.0	135.0	B		
*4	1 280 x 1 024	91.1	85.0	157.5	B		
SXGA+ *4	1 400 x 1 050	64.0	60.0	108.0	B		
*4	1 400 x 1 050	65.1	59.9	122.4	B		
UXGA60 *4	1 600 x 1 200	75.0	60.0	162.0	B		
WXGA <sup>*5</sup> *4	1 280 x 768	47.8	59.9	79.5	A		
*4	1 280 x 800	49.7	59.8	83.5	A		
	1 440 x 900	55.9	59.9	106.5	A		

\*1. The "i" appearing after the resolution indicates an interlaced signal.

\*2. The following symbols are used to indicate picture quality.

AA Maximum picture quality can be obtained.

A Signals are converted by the image processing circuit before picture is projected.

B Some loss of data occurs to make projection easier.

\*3. Signals with "OK" are compatible with the "RESIZING" function. See "RESIZING" on page 33.

\*4. Signals that are compatible with the "FRAME LOCK" function. See "FRAME LOCK" on page 33.

\*5. Signals that are compatible with the CVT standard.

## Serial terminal

The serial connector which is on the connector panel of the projector conforms to the RS-232C interface specification, so that the projector can be controlled by a personal computer which is connected to this connector.

### Connection

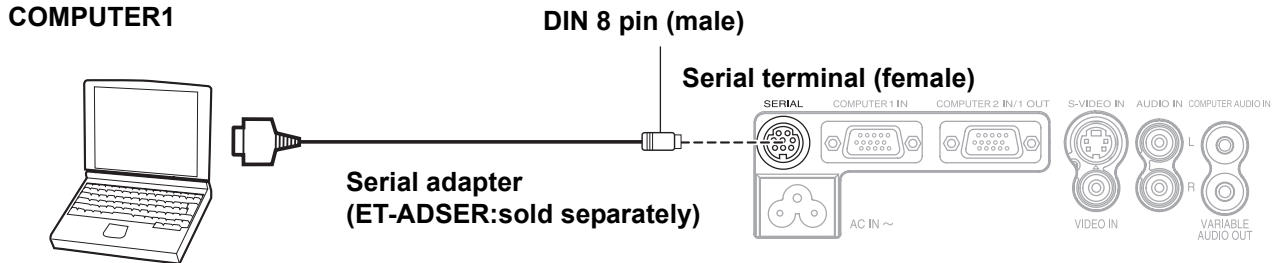

### Pin assignments and signal names

	Pin No.	Signal name	Contents
	① ② ⑥		
③		RXD	Received data
④		GND	Earth
⑤		TXD	Transmitted data
⑦ ⑧			NC

### Communication settings

Signal level	RS-232C	Character length	8 bits
Sync. method	Asynchronous	Stop bit	1 bit
Baud rate	9 600 bps	X parameter	None
Parity	None	S parameter	None

### Basic format

STX	Command	:	Parameter	ETX
Start byte (02h)	3 bytes	1 byte	1 byte - 4 bytes	End (03h)

The data streaming from the computer will start with STX, and proceed to Command, Parameter and end with ETX. You can add the required parameter.

- The projector can not receive any command for approximately 10 seconds after the lamp is switched on and for approximately 1 second after the cooling fan stops operating and the projector has returned to standby mode (approximately 90 seconds after the indicator switches off).  
Be sure to wait until the lengths of time mentioned above have passed before sending the command.
- If sending multiple commands, check that a response has been received from the projector for one command before sending the next command.
- When a command which does not require parameters to be sent, the colon (:) is not required.
- If an incorrect command is sent from the personal computer, the ER401 command will be sent from the projector to the personal computer.



## Computer connection guidance

You can switch the signals which to output from the **COMPUTER1 OUT** terminal by pressing the computer key command. The key commands are depend on the manufactures. If you select the computer terminals which has no signals while the **INPUT GUIDE** is set to **DETAILED**, the computer connection guidance will be displayed.

Manufacturer	Key command	Manufacturer	Key command	Manufacturer	Key command
Panasonic NEC	Fn + F3	TOSHIBA SHARP HP	Fn + F5	IBM SONY	Fn + F7
				Apple	F7
FUJITSU	Fn + F10	EPSON DELL	Fn + F8	Other	Fn + 

**NOTE:**

- The computer connection guidance will disappear after 5 minutes.
- Please refer the instructions which provided with the computers for more detailed information.

## Technical Information

### Specifications

<b>Power supply</b>		AC 100 - 240 V 50 Hz/60 Hz
<b>Power consumption</b>		240 W During standby (when fan is stopped): 4 W
<b>Amps</b>		2.8 A - 1.3 A
<b>LCD panel</b>	<b>Panel size (diagonal)</b>	0.6 type (15.24 mm)
	<b>Aspect ratio</b>	4 : 3
	<b>Display method</b>	3 transparent LCD panels (RGB)
	<b>Drive method</b>	Active matrix method
	<b>Pixels</b>	PT-LB51NTU/PT-LB51U: 786 432 (1 024 x 768) x 3 panels PT-LB51SU: 480 000 (800 x 600) x 3 panels
<b>Lens</b>		Manual zoom (1 - 1.2 x)/Manual focus F 1.6 - 1.9, f 18.8 mm - 22.6 mm
<b>Lamp</b>		UHM lamp (165 W)
<b>Optical output</b>		2 000 lm*1
<b>Light output uniformity*2</b>		90 %
<b>Contrast ratio</b>		400 : 1
<b>Operating environment</b>		Temperature 0 °C - 40 °C (32 °F - 104 °F) When the <b>HIGHLAND</b> (page 36) is set to ON: 0 °C - 35 °C (32 °F - 95 °F) Humidity 20% - 80% (no condensation)
<b>Scanning frequency*3 (for RGB signal)</b>	<b>Horizontal scanning frequency</b>	15 kHz - 91 kHz
	<b>Vertical scanning frequency</b>	50 Hz - 85 Hz
	<b>Dot clock frequency</b>	Less than 100 MHz
<b>COMPONENT (YPbPr) signals</b>		480i, 480p, 576i, 576p, 720/60p, 1 080/50i, 1 080/60i,
<b>Color system</b>		7 (NTSC/NTSC 4.43/PAL/PAL-M/PAL-N/PAL60/SECAM)
<b>Projection size</b>		33" - 300" (838.2 mm - 7 620 mm)
<b>Throw distance</b>		PT-LB51NTU/PT-LB51U: 1.1 m - 11.1 m (3'7" - 36'5") PT-LB51SU: 1.1 m - 10.9 m (3'7" - 35'9")
<b>Optical axis shift</b>		6:1 (fixed)
<b>Screen aspect ratio</b>		4 : 3
<b>Installation</b>		FRONT/DESK, FRONT/CEILING, REAR/DESK, REAR/CEILING (Menu selection method)
<b>Speaker</b>		1 piece 4 cm X 2cm oval
<b>Max. useable volume output</b>		1.0 W (mono)

\*1. ISO 21118 conformity:

The values given are averages based on mass-production articles, and the lower limit values at the time of shipment are 80 % of the indicated values.

\*2. ISO 21118 conformity:

The values given are averages based on mass-production articles, and the lower limit values at the time of shipment are 80 % of the indicated values.

\*3. See "List of compatible signals" on page 44 for available signals.



<b>Terminals</b>	<b>S-VIDEO IN</b>	Single - line, Mini DIN 4p Y: 1.0 V [p-p], C: 0.286 V [p-p], 75 Ω	
	<b>VIDEO IN</b>	Single - line, RCA pin jack 1.0 V [p-p], 75Ω	
	<b>COMPUTER1 IN</b>	Single - line, D - sub HD 15-pin (female) During RGB signals input R.G.B. 0.7 V [p-p], 75 Ω G.SYNC 1.0 V [p-p], 75 Ω HD, VD TTL high impedance, automatic positive/negative polarity compatible	
		During YPBPR signals input Y 1.0 V [p-p] (Including sync), 75 Ω PB,PR 0.7 V [p-p], 75 Ω	
	<b>COMPUTER2 IN/ 1 OUT</b>	Single - line, D - sub HD 15-pin (female) Selectable for input and output by menu operation. During RGB signals input/output R.G.B. 0.7 V [p-p], 75 Ω G.SYNC 1.0 V [p-p], 75 Ω HD, VD TTL high impedance, automatic positive/negative polarity compatible	
		During YPBPR signals input Y 1.0 V [p-p] (Including sync), 75 Ω PB,PR 0.7 V [p-p], 75 Ω	
	<b>AUDIO IN</b>	Single - line, 0.5V [rms], RCA pin jack x 2 (L - R)	
	<b>COMPUTER AUDIO IN</b>	Single - line, 0.5V [rms], M3 jack (Stereo MINI)	
	<b>VARIABLE AUDIO OUT</b>	Single - line, 0.5V [rms], M3 jack (Stereo MINI) Monitor output/stereo compatible 0 V [rms] - 2.0 V [rms] (variable)	
<b>SERIAL</b>	DIN 8-pin RS-232C compatible		
<b>Wireless LAN (PT-LB51NTU only)</b>	<b>Compatible</b>	IEEE802.11b/IEEE802.11g (Wireless LAN standard protocol)	
	<b>Wireless channel</b>	IEEE802.11b/IEEE802.11g: 1 - 11 channels	
	<b>Distance</b>	30 m (98'5") Depends on the usage environment	
<b>Cabinet</b>	Moulded plastic (PC+ABS)		
<b>Dimensions</b>	Width	297 mm (11 - 11/16")	
	Height	57 mm (2 - 7/32") (Not including the projection parts)	
	Length	210 mm (8 - 1/4")	
<b>Weight</b>	PT-LB51NTU: 1.9 kg (4.2 lbs.) PT-LB51U/PT-LB51SU: 1.8 kg (4.0 lbs.)		
<b>Certifications</b>	UL60950 FCC Class B	C-UL	
<b>Remote control</b>	<b>Power supply</b>	3 V DC ( <b>AA batteries</b> x 2)	
	<b>Operating range</b>	Approx. 15 m (49'2") (when operated directly in front of signal receptor)	
	<b>Weight</b>	117 g (4.2 ozs.) (including batteries)	
	<b>Dimensions</b>	Width	48 mm (1 - 7/8")
Length		163 mm (6 - 13/32")	
Height		24.5 mm (5/16") (not including surface projection parts)	
<b>Options</b>	<b>Ceiling bracket</b>	ET-PKB50	
	<b>Wireless remote control unit</b>	ET-RM300	
	<b>Serial adapter</b>	ET-ADSER (DIN 8-pin/D-sub 9-pin)	

Dimensions

<Units: mm (inch)>

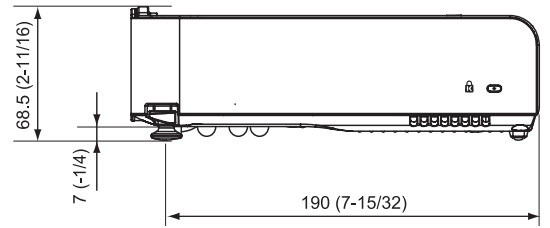
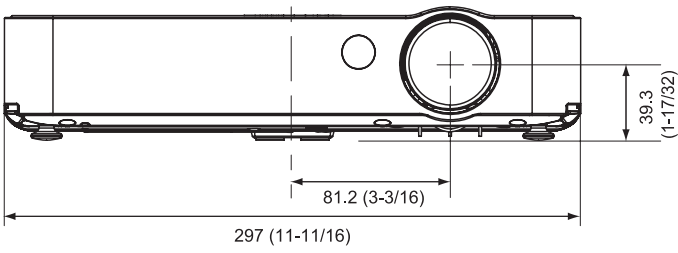
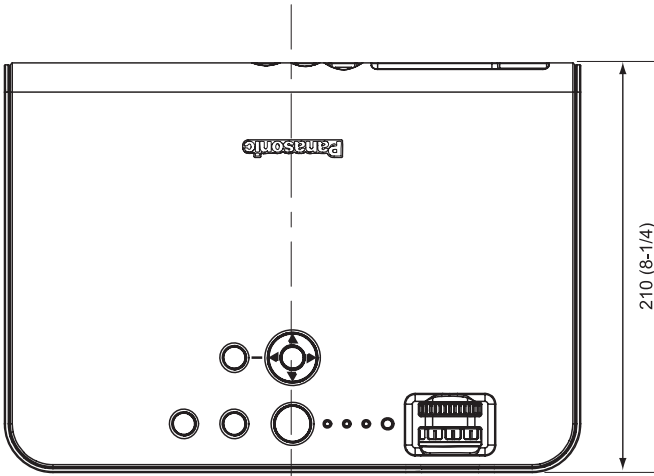

### Trademark acknowledgments

- VGA and XGA are trademarks of International Business Machines Corporation.
- S-VGA is a registered trademark of the Video Electronics Standards Association.
- The font used in the on-screen displays is a Ricoh bitmap font, which is manufactured and sold by Ricoh Company, Ltd.

All other trademarks are the property of the various trademark owners.

These Operating Instructions are printed on recycled paper.

# Index

<b>A</b>		<b>E</b>	
AC IN .....	13	ENTER	
Accessories .....	9	Control panel button .....	12
AI .....	31	Remote control button .....	10
Air exhaust port .....	13	<b>F</b>	
Air filter .....	13	Focus ring .....	12, 22
Air intake port .....	13	FRAME LOCK .....	33
ASPECT .....	32	FREEZE	
AUDIO IN .....	13	Remote control .....	24
AUTO SETUP		Remote control button .....	10
Menu .....	35	Front adjustable legs .....	13, 17, 22
Remote control .....	23	Front leg adjusters .....	12, 17, 22
Remote control button .....	10	FUNCTION BUTTON .....	34
<b>B</b>		<b>H</b>	
BACK COLOR .....	36	Hand strap .....	11
Battery compartment .....	10	HIGHLAND .....	36
BLACKBOARD .....	36	<b>I</b>	
BRIGHTNESS .....	30	INDEX-WINDOW	
<b>C</b>		Remote control .....	25
Calculation methods		Remote control button .....	10
16:9 .....	15	INPUT GUIDE .....	34
4:3 .....	15	INPUT PASSWORD .....	37
CD-ROM		INPUT SELECT	
Accessories .....	9	Control panel button .....	12
Cleaning .....	40	Remote control button .....	10
CLOCK PHASE .....	32	Selecting .....	22, 24
COLOR .....	30	INSTALLATION	
COLOR TEMPERATURE .....	30	Menu .....	35
COMPUTER		Projection method .....	16
Connection guidance .....	47	<b>K</b>	
Remote control .....	24	KEYSTONE .....	32
Remote control button .....	10	<b>L</b>	
COMPUTER AUDIO IN .....	13	LAMP	
COMPUTER SEARCH (PT-LB51NTU only).....	10	Indicator .....	12
COMPUTER1 IN .....	13	Indicator status .....	39
COMPUTER2 IN/1 OUT .....	13	LAMP RUNTIME .....	35
COMPUTER2 SELECT .....	34	Lamp unit compartment .....	13
Connections .....	18	Replacing .....	41
Connector Panel .....	13	LAMP POWER .....	34
CONTRAST .....	30	LANGUAGE .....	28, 33
CONTROL PANEL .....	12, 35	Luminance Sensor .....	12
<b>D</b>		<b>M</b>	
DAYLIGHT VIEW .....	31	MENU	
DEFAULT		Control panel button .....	12
Remote control .....	25	Main menu .....	28
Remote control button .....	10	Navigation .....	27
DETAILED SETUP		Remote control button .....	10
OPTION menu .....	36	MULTI-LIVE (PT-LB51NTU only).....	10
PICTURE menu .....	31	<b>N</b>	
DIGITAL ZOOM		Navigation buttons	
Remote control .....	26	Control panel button .....	12
Remote control button .....	10	Remote control button .....	10
Dimensions .....	50	NOISE REDUCTION .....	31
Direct power off .....	20	<b>O</b>	
DIRECT POWER ON		OPTION menu .....	34
Function .....	20	OSD DESIGN .....	36
Menu .....	35		
DOT CLOCK .....	32		

<b>P</b>		TEXT DISPLAY .....	37
PAGE (PT-LB51NTU only) .....	10	Throw distance	
PASSWORD CHANGE .....	37	16:9 .....	14
PICTURE menu .....	30	4:3 .....	14
PICTURE MODE .....	30	Throwing angle .....	17
POSITION .....	32	TINT .....	30
POSITION menu .....	32	Troubleshooting .....	43
POWER		TV-SYSTEM .....	31
Control panel .....	12	<b>V</b>	
Indicator status .....	20	VARIABLE AUDIO OUT .....	13
Remote control button .....	10	VIDEO	
Power cord		Remote control .....	24
Accessories .....	9	Remote control button .....	10
Connecting .....	20	VIDEO IN .....	13
POWER OFF TIMER .....	35	VOLUME .....	36
Projection lens .....	12	Remote control .....	26
<b>R</b>		Remote control button .....	10
REALTIME KEYSTONE .....	32	<b>W</b>	
Remote control		WHITE BALANCE .....	31
Accessories .....	11	WIRELESS (PT-LB51NTU only)	
Signal emitter .....	12	Remote control .....	24
Signal receptor .....	14	Remote control button .....	10
RESIZING .....	33	<b>X</b>	
RETURN		XGA MODE .....	36
Remote control button .....	10	<b>Z</b>	
RGB/YPbPr .....	36	Zoom ring .....	12, 22
Ring			
Focus ring .....	12		
Zoom ring .....	12		
<b>S</b>			
Screen size			
16:9 .....	14		
4:3 .....	14		
Security lock .....	12		
SECURITY menu .....	37		
SERIAL .....	13		
Basic format .....	45		
Cable specifications .....	46		
Communication settings .....	45		
Connection .....	45		
Control commands .....	46		
Pin assignments .....	45		
SHARPNESS .....	30		
SHUTTER			
Remote control .....	24		
Remote control button .....	10		
SIGNAL SEARCH .....	35		
Speaker .....	13		
Specifications .....	48		
STARTUP LOGO .....	34		
STILL MODE .....	31		
Sub-menu .....	28		
S-VIDEO IN .....	13		
SXGA MODE .....	36		
<b>T</b>			
Technical Information .....	44		
TEMP			
Indicator .....	12		
Indicator status .....	39		
TEXT CHANGE .....	37		

# Avis important concernant la sécurité

## Cher client Panasonic:

Ce mode d'emploi vous donne toutes les informations concernant l'utilisation de ce projecteur. Nous espérons qu'il vous aidera à utiliser au mieux votre nouvel appareil, et que votre projecteur à cristaux liquides Panasonic vous donnera entière satisfaction. Le numéro de série du produit se trouve au bas du produit. Le noter dans l'espace prévu ci-dessous et conserver ce manuel pour le cas où des réparations seraient nécessaires à l'avenir.

Numéro de modèle: **PT-LB51NTU / PT-LB51U / PT-LB51SU**

Numéro de série:

**AVERTISSEMENT:** POUR REDUIRE LES RISQUES DE FEU OU DE CHOC ÉLECTRIQUE, NE PAS EXPOSER CE PRODUIT À L'EAU OU À L'HUMIDITÉ.

**Alimentation:** Ce projecteur LCD est conçu pour fonctionner sur secteur de 100 V - 240 V, 50 Hz/60 Hz seulement.

**ATTENTION:** Le cordon d'alimentation secteur fourni avec le projecteur peut être utilisé uniquement pour une alimentation électrique de 125 V, 7 A maximum. Si on veut l'utiliser avec une tension ou un courant plus forts, on doit se procurer un autre cordon d'alimentation de 250 V. Si on utilise le cordon fourni sous ces conditions, risque de provoquer un incendie.

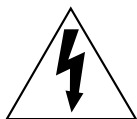

Le symbole de la flèche en forme d'éclair, dans un triangle, avertit l'utilisateur de la présence de «tensions dangereuses» à l'intérieur du produit qui peuvent être de force suffisante pour constituer un risque de choc électrique aux personnes.



Le point d'exclamation dans un triangle avertit l'utilisateur de la présence d'instructions importantes concernant l'utilisation et l'entretien (réparation) dans la littérature accompagnant le produit.

**ATTENTION:** Cet appareil est équipé d'une fiche de courant à trois broches avec mise à la terre. Ne pas retirer la broche de mise à la masse de la fiche. Cette fiche ne pourra être utilisée que dans une prise avec mise à la terre. Ceci est une précaution sécuritaire. S'il est impossible d'insérer la fiche dans la prise, s'adresser à un électricien. Ne pas annuler la protection de la fiche à mise à la terre.

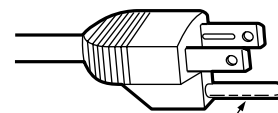

Ne pas retirer

Pursuant to at the directive 2004/108/EC, article 9(2)  
Panasonic Testing Centre  
Panasonic Service Europe, a division of Panasonic Marketing Europe GmbH  
Winsbergring 15, 22525 Hamburg, F.R. Germany

**NOTICE:**

- Ce produit possède une lampe à décharge haute intensité (DHI) qui contient du mercure. Son élimination peut être réglementée dans votre s à cause de considérations environnementales. Pour d'amples informations sur la mise au rebut ou le recyclage, veuillez contacter vos autorités locales ou aller au site Web de l'Electronics Industries Alliance: <http://www.eiae.org>

## AVERTISSEMENT:

Cet équipement a été soumis à des tests qui ont démontré que celui-ci respectait les limites spécifiées pour les appareils numériques de la classe B aux termes de la partie 15 des règles de la FCC (Federal Communications Commission U.S.A.). Ces limites ont pour objet de fournir une protection raisonnable contre les interférences nuisibles dans le cas d'une installation en milieu résidentiel. Cet équipement produit, utilise et peut rayonner de l'énergie de haute fréquence, et s'il n'est pas installé et utilisé conformément aux instructions fournies avec celui-ci, peut provoquer des interférences nuisibles aux communications radio. En outre, même en cas d'utilisation conforme, il n'est pas garanti qu'aucune interférence ne saurait survenir avec certaines installations. Si cet équipement s'avère nuire à la bonne réception d'émissions de radiophonie ou de télévision, ce que l'on pourra déterminer en mettant l'équipement successivement hors tension puis sous tension, il est conseillé de tenter de remédier au problème par l'une des méthodes suivantes:

- Réorientez ou déplacez l'antenne du récepteur;
- Éloignez l'équipement du récepteur;
- Branchez l'équipement dans une prise de courant située sur un circuit autre que celui qui alimente la prise de courant du récepteur;
- Demandez conseil à votre distributeur ou à un technicien de radio/télévision expérimenté.

## ATTENTION:

Pour assurer la bonne conformité, utilisez uniquement des câbles d'interface blindés lorsque vous connectez des ordinateurs ou des périphériques. Toute modification non autorisée de cet équipement annulera le droit de l'utilisateur à utiliser cet équipement. Si le port sériel est utilisé pour connecter un ordinateur personnel afin de commander le projecteur depuis l'extérieur, il faut utiliser le câble d'interface sériel en option RS-232C avec une âme en ferrite. Tout changement ou modification non autorisé à cet équipement annule l'autorité de faire fonctionner cet appareil.

## Avertissement de la FCC relative à l'exposition RF : (si fourni avec un appareil sans fil)

- Cet équipement est conforme aux limitations concernant l'exposition aux radiations établies par la FCC dans un environnement non contrôlé.
- Cet équipement a été approuvé pour un fonctionnement mobile et requiert de respecter une distance minimum de 20 cm entre l'antenne(s) et toutes les parties de votre corps (sauf les extrémités des mains, poignets et pieds) durant les modes de fonctionnement sans fil.
- Cet équipement ne peut pas être utilisé avec d'autres transmetteurs installés, qui peuvent être capable de transmission simultanée.

## ADVERTENCIA:

- Ne peut être utilisé dans une salle d'ordinateurs telle que définie dans la norme ANSI/NFPA 75 Standard for Protection of Electronic Computer/Data Processing Equipment.
- Pour l'équipement branché en permanence, un dispositif de dis connexion d'accès facile doit être incorporé dans le câble d'installation du bâtiment;
- Pour l'équipement bran chable, une prise secteur d'accès facile doit être installée près de l'équipement.

## Déclaration de conformité

Modèle n°: PT-LB51NTU / PT-LB51U / PT-LB51SU  
 Désignation commerciale: **Panasonic**  
 Fabricant responsable: Panasonic Corporation of North America  
 Adresse: One Panasonic Way, Secaucus, New Jersey 07094  
 Téléphone: (888) 411 - 1996  
 Email: projectorsupport@us.panasonic.com

Cet appareil est conforme à la partie 15 des règles de la FCC (Federal Communications Commission U.S.A.) ce qui signifie: (1) que l'appareil ne produit pas d'interférences nuisibles, et (2) que l'appareil est capable de supporter sans danger les interférences reçues, y compris celles susceptibles de perturber son fonctionnement.

## Informations sur l'évacuation des déchets dans les pays ne faisant pas partie de l'Union européenne



Ce symbole n'est reconnu que dans l'Union européenne. Pour vous débarrasser de ce produit, veuillez contacter les autorités locales ou votre revendeur afin de connaître la procédure d'élimination à suivre.

# Précautions de sécurité

## AVERTISSEMENT

**Si l'on remarque une émission de fumée, d'odeurs suspectes ou de bruits provenant du projecteur, débrancher la fiche du cordon d'alimentation de la prise de courant.**

- Ne pas continuer d'utiliser le projecteur dans ces cas-là, autrement cela peut entraîner un incendie ou des chocs électriques.
- Après s'être assuré que de la fumée ne se dégage plus, s'adresser à un centre technique agréé et demander que les réparations nécessaires soient faites.
- Le fait de réparer le projecteur soi-même est très dangereux, et ne doit jamais être fait.

**Ne pas installer ce projecteur dans un endroit qui n'est pas assez résistant pour supporter le poids du projecteur.**

- Si l'emplacement d'installation n'est pas assez résistant, le projecteur risque de tomber et causer de graves blessures et (ou) des dommages.

**Demander à un technicien qualifié d'installer le projecteur par exemple s'il est installé au plafond.**

- Si l'installation n'est pas faite correctement, cela peut entraîner des blessures ou des chocs électriques.
- Ne pas utiliser un support de montage au plafond qui n'est pas agréé.

**Si de l'eau ou des objets étrangers pénètrent dans le projecteur, si le projecteur tombe, ou si le boîtier est endommagé, débrancher immédiatement la fiche du cordon d'alimentation de la prise de courant.**

- Si l'on continue d'utiliser le projecteur dans cette condition, cela peut entraîner un incendie ou des chocs électriques.
- S'adresser à un centre technique agréé pour que les réparations nécessaires puissent être faites.

**Ne pas surcharger la prise de courant.**

- Si l'alimentation est surchargée (par exemple, par l'utilisation de trop d'adaptateurs), cela risque de faire surchauffer le projecteur et peut entraîner un incendie.

**Ne jamais entreprendre toute modification quelconque ou démontage du projecteur.**

- Des hautes tensions qui peuvent causer de graves blessures sont présentes à l'intérieur du projecteur.
- Pour toute inspection, réglage ou réparation, s'adresser à un centre technique agréé.

**Nettoyer la fiche du cordon d'alimentation régulièrement afin d'éviter toute accumulation de poussière.**

- Si de la poussière s'accumule sur la fiche du cordon d'alimentation, l'humidité peut endommager l'isolant et entraîner un incendie. Débrancher la fiche du cordon d'alimentation de la prise de courant et l'essuyer avec un tissu sec.
- Si le projecteur n'est pas utilisé pendant une période prolongée, débrancher la fiche du cordon d'alimentation de la prise de courant.

**Faire attention à ne pas endommager le cordon d'alimentation.**

- Ne pas endommager le cordon d'alimentation, ne pas le modifier, ne pas le placer sous des objets lourds, ne pas le chauffer, ne pas le placer près d'objets chauffants, ne pas le tordre, ne pas le plier ou le tirer excessivement et ne pas le rouler en boule.
- Si le cordon d'alimentation est endommagé, cela peut entraîner un incendie et des chocs électriques.
- Si le cordon d'alimentation est endommagé, le faire réparer par un centre technique agréé.

**Ne pas manipuler le cordon d'alimentation avec les mains mouillées.**

- Cela peut entraîner des chocs électriques.

**Brancher la fiche du cordon d'alimentation fermement dans la prise de courant.**

- Si la fiche n'est pas complètement insérée, cela peut entraîner des chocs électriques ou la faire surchauffer.
- Si la fiche est endommagée ou la plaque de la prise desserrée, celles-ci ne devraient pas être utilisées.

**Ne pas placer le projecteur sur des surfaces instables.**

- Si le projecteur est placé sur une surface qui est inclinée ou instable, il risque de tomber ou de se renverser et cela peut causer des blessures ou des dommages.

**Ne pas placer le projecteur dans l'eau ou ne pas le laisser se mouiller.**

- Sinon cela peut causer un incendie ou des chocs électriques.

**Ne pas placer le projecteur sur des matériaux comme du tapis ou du tissu éponge.**

- Cela peut provoquer une surchauffe du projecteur, pouvant entraîner des brûlures, un incendie ou endommager le projecteur.

**Ne pas placer des récipients de liquide sur le projecteur.**

- Si de l'eau se renverse sur le projecteur ou pénètre dans celui-ci, il y aura risque d'incendie ou d'électrocution.
- Si de l'eau entre à l'intérieur du projecteur, entrer en contact avec un centre technique agréé.

**Ne pas mettre d'objets étrangers dans le projecteur.**

- Ne pas insérer d'objets métalliques ou inflammables dans les orifices de ventilation ou les faire tomber sur le projecteur, car cela peut causer un incendie ou des chocs électriques.

**Veiller à ce que les bornes + et – des piles n'entrent pas en contact avec des objets métalliques tels que colliers ou épingles à cheveux.**

- Sinon, les piles risquent de fuir, de surchauffer, d'exploser ou de prendre feu.
- Ranger les piles dans un sac en plastique, et ne pas les ranger à proximité d'objets métalliques.



### Ne pas toucher le liquide provenant des fuites des piles.

- Si vous touchez le liquide des fuites, cela pourrait abîmer votre peau. Enlever le liquide à l'eau claire et rechercher immédiatement le secours d'un médecin.
- Si vous recevez du liquide des fuites dans les yeux, cela pourrait provoquer la cécité ou des blessures. Ne pas vous frotter les yeux, enlever le liquide à l'eau claire et rechercher immédiatement le secours d'un médecin.

### Pendant un orage, ne pas toucher le projecteur ou le câble.

- Il y a risque d'électrocution.

### Ne pas utiliser l'appareil dans un bain ou une douche.

- Il y a risque d'incendie ou d'électrocution.

### Veillez à ce que le faisceau lumineux n'éclaire pas directement votre peau pendant que vous utilisez le projecteur.

- Une lumière intense est émise par l'objectif du projecteur. Si vous vous placez dans ce faisceau lumineux, celui-ci risquera de vous blesser ou de vous abîmer la peau.

### Ne pas regarder directement dans l'objectif pendant que le projecteur fonctionne.

- Une lumière intense est émise par l'objectif du projecteur. Si l'on regarde directement dans cette lumière, elle risque de causer des blessures et de graves lésions aux yeux.
- Veiller particulièrement à ce que les enfants ne regardent pas dans l'objectif. En outre, éteindre le projecteur si on le laisse sans surveillance.

### Ne pas placer les mains ou autres objets près de l'orifice de sortie d'air.

- De l'air chaud sort par l'orifice de sortie d'air. Ne pas placer les mains, le visage ou d'autres objets qui ne peuvent résister à la chaleur près de cette sortie d'air [laisser un espace d'au moins 15 cm], sinon des brûlures ou des dommages risqueraient de s'ensuivre.

### Le remplacement de la lampe ne doit être effectué que par un technicien qualifié.

- La lampe a une pression interne élevée. Si elle est manipulée incorrectement, une explosion peut s'ensuivre.
- La lampe peut être facilement endommagée si elle est heurtée contre des objets durs ou si on la laisse tomber et des blessures et des mauvais fonctionnements peuvent s'ensuivre.

### Lors du remplacement de la lampe, la laisser refroidir pendant au moins une heure avant de la manipuler.

- Le couvercle de la lampe devient très chaud, et on risque de se brûler si on le touche.

### Avant de remplacer la lampe, veiller à débrancher la fiche du cordon d'alimentation de la prise de courant.

- Il y a risque d'électrocution ou d'explosion.

### Ne pas laisser des enfants ou des animaux domestiques toucher la télécommande.

- Après avoir utilisé la télécommande, la ranger hors de portée des enfants ou des animaux domestiques.

### N'installez pas le projecteur à l'extérieur.

- Ce projecteur est conçu pour être utilisé à l'intérieur uniquement.

## MISES EN GARDE

### Ne pas obstruer les orifices d'entrée et de sortie d'air.

- Cela risque de faire surchauffer le projecteur, et causer un incendie ou endommager le projecteur.
- Ne pas installer le projecteur dans des endroits étroits, mal ventilés tels que des placards ou des étagères.
- Ne pas placer le projecteur sur des tissus ou du papier, ces matériaux peuvent être aspirés dans l'orifice d'entrée d'air.

### Débrancher toujours tous les câbles avant de déplacer le projecteur.

- Le fait de déplacer le projecteur avec des câbles branchés peut endommager les câbles, ce qui pourrait causer un incendie ou des chocs électriques.

### Ne pas installer le projecteur dans des endroits humides ou poussiéreux ou dans des endroits où le projecteur peut entrer en contact avec des fumées grasses ou de la vapeur.

- L'utilisation du projecteur dans de telles conditions peut causer un incendie, des chocs électriques ou une détérioration du boîtier en plastique. Une détérioration du plastique risquerait en effet d'entraîner une chute du projecteur en cas d'installation au plafond.

### Ne pas installer le projecteur dans un environnement à haute température, tel qu'à proximité d'un chauffage ou en plein soleil.

- Sinon cela peut causer un incendie, un dysfonctionnement ou une détérioration du plastique.

### Pour débrancher le cordon d'alimentation, tenir la fiche et non pas le cordon.

- Si le cordon d'alimentation est tiré, le cordon sera endommagé et cela peut causer un incendie, des courts-circuits ou des chocs électriques sérieux.

### Ne pas placer d'objets lourds sur le projecteur.

- Cela peut déséquilibrer le projecteur et le faire tomber, ce qui peut entraîner des dommages ou des blessures.

### Ne pas court-circuiter, chauffer ou démonter les piles, et ne pas les mettre dans l'eau ou dans le feu.

- Sinon, les piles risqueront de surchauffer, de fuir, d'exploser ou de prendre feu, et donc de causer des brûlures ou d'autres blessures.

## Précautions de sécurité

**Lorsqu'on insère les piles, veiller à ce que les polarités (+ et -) soient bien respectées.**

- Si l'on insère les piles incorrectement, elles risquent d'exploser ou de fuir, ce qui peut causer un incendie, des blessures ou une contamination du logement des piles et de la zone environnante.

**Utiliser uniquement les piles spécifiées.**

- Si l'on insère des piles d'un type différent, elles risquent d'exploser ou de fuir, ce qui peut causer un incendie, des blessures ou une contamination du logement des piles et de la zone environnante.

**Ne pas mélanger des piles usées et des piles neuves.**

- Si l'on insère les piles incorrectement, elles risquent d'exploser ou de fuir, ce qui peut causer un incendie, des blessures ou une contamination du logement des piles et de la zone environnante.

**Si l'on n'utilise pas le projecteur pendant une période prolongée, débrancher la fiche du cordon d'alimentation de la prise de courant et retirer les piles de la télécommande.**

- Si de la poussière s'accumule sur la fiche du cordon d'alimentation, l'humidité ainsi créée risquera d'endommager l'isolation, ce qui peut provoquer un incendie.
- Le fait de laisser les piles à l'intérieur de la télécommande pendant trop longtemps en cas d'inactivité risque de causer une dégradation de l'isolation, une fuite de courant ou même des explosions, ce qui pourrait causer un incendie.

**Ne pas peser de tout son poids sur ce projecteur.**

- On risque de tomber ou de casser l'appareil, ce qui peut causer des blessures.
- Veiller tout particulièrement à ce que les enfants ne se tiennent pas debout ou ne s'asseyent pas sur le projecteur.

**Nous faisons tous les efforts possibles afin de préserver l'environnement. Prière de rapporter l'appareil, s'il n'est pas réparable, à votre revendeur ou à un centre de recyclage.**

## Précautions lors du transport

**Ne pas soumettre le projecteur à des vibrations ou des chocs excessifs.**

- L'objectif du projecteur doit être manipulé avec soin.

**Retirer rapidement les piles de la télécommande.**

- Si vous laissez des piles usagées dans la télécommande pendant une longue période, cela risque de provoquer des fuites, une hausse anormale de la température interne ou une explosion.

**Si la lampe s'est cassée, ventiler immédiatement la pièce. Ne pas toucher ni approcher le visage des morceaux cassés.**

- Le non respect de cette consigne peut entraîner l'absorption du gaz par l'utilisateur. Ce gaz se dégage lorsque la lampe est cassée et il contient presque autant de mercure qu'une lampe fluorescente, de plus les morceaux cassés peuvent provoquer des blessures.
- Si vous pensez avoir inhalé du gaz ou que du gaz a pénétré dans votre bouche ou dans vos yeux, contactez un médecin immédiatement.
- S'adresser au revendeur pour le remplacement de la lampe et l'inspection de l'intérieur du projecteur.

**Débrancher la fiche du cordon d'alimentation de la prise de courant comme mesure de sécurité avant d'effectuer tout nettoyage.**

- Sinon cela peut causer des chocs électriques.

**Demander à un centre technique agréé de nettoyer l'intérieur du projecteur au moins une fois par an.**

- S'il n'est pas nettoyé et que de la poussière s'accumule à l'intérieur du projecteur, cela peut causer un incendie ou des problèmes de fonctionnement.
- Il est recommandé de nettoyer l'intérieur du projecteur avant l'arrivée de la saison humide. Demander au centre technique agréé le plus proche de nettoyer le projecteur lorsque cela est requis. Se renseigner auprès du centre technique agréé pour le coût du nettoyage.

**Veiller à utiliser la sacoche de transport fournie lorsqu'on déplace le projecteur.**

- Lorsqu'on place le projecteur dans la sacoche de transport, le placer de façon que l'objectif soit orienté vers le haut. Ne pas placer le projecteur avec ses pieds réglables déployés, et ne rien mettre d'autre que le projecteur, les câbles et la télécommande dans la sacoche.

## Précautions lors de l'installation

**Éviter de l'installer dans les endroits sujets à des vibrations ou à des chocs.**

- Les pièces internes peuvent être endommagées, ce qui peut causer des pannes ou des accidents.

**Éviter d'installer le projecteur à des endroits sujets à des changements de température brusques, à proximité d'un climatiseur ou d'un matériel d'éclairage.**

- La durée de vie de la lampe risquerait d'être réduite, ou le projecteur risquerait de s'éteindre. « Indicateur TEMP » à la page 41.

**Ne pas installer le projecteur près de lignes d'alimentation électrique à haute tension ou de moteurs.**

- Le projecteur peut être soumis à des interférences électromagnétiques.

**Si le projecteur est installé au plafond, demander à un technicien qualifié de faire tous les travaux d'installation.**

- Il faut acheter le kit d'installation séparé (numéro de modèle: ET-PKB50). En outre, tous les travaux d'installation doivent être exécutés uniquement par un technicien qualifié.

**Si l'on utilise ce projecteur à un endroit élevé (au dessus de 1 400 m), régler MONTAGNE sur OUI. Voir « MONTAGNE » à la page 38.**

- Le non-respect de ces consignes peut entraîner un dysfonctionnement ou peut raccourcir la durée de vie de la lampe ou d'autres composants.

## Précautions lors de l'utilisation

**Afin d'obtenir la meilleure qualité d'image**

- Fermer les rideaux ou les volets de toutes les fenêtres et éteindre les lampes fluorescentes situées à proximité de l'écran afin que la lumière extérieure ou la lumière des lampes intérieures n'éclaire pas l'écran.

**Ne pas toucher aux surfaces de l'objectif avec les mains nues.**

- Si la surface de l'objectif est salie par des empreintes digitales ou autre, celles-ci seraient agrandies et projetées sur l'écran.

**Affichage à cristaux liquides**

- Ne pas projeter la même image pendant une longue durée, car elle risquerait de former une après-image sur l'affichage à cristaux liquides.
- L'affichage à cristaux liquides du projecteur a été fabriqué en utilisant une technologie de haute précision afin d'offrir une image très détaillée. Il est possible que parfois quelques pixels figés apparaissent sur l'écran sous forme de points fixes bleus, verts ou rouges. Il est alors recommandé d'éteindre le projecteur puis de le rallumer environ 1 heure après. Bien noter que ceci n'affecte pas le bon fonctionnement de votre LCD.

**Écran**

- N'appliquer aucun produit volatil qui risque de décolorer l'écran, et veiller à ce que l'écran ne soit pas sale ou endommagé.

**Le projecteur possède une lampe au mercure à haute pression interne avec les caractéristiques suivantes.**

- La luminosité de la lampe dépend de la durée d'utilisation.
- Des chocs ou des écaillages sur la lampe pourraient la faire exploser ou écourter la durée de vie de la lampe.
- La lampe pourrait exploser occasionnellement après l'utilisation du projecteur.
- La lampe pourrait exploser si le projecteur est utilisé après le délai conseillé de remplacement de la lampe.
- La durée de vie de la lampe dépend des caractéristiques individuels de la lampe, des conditions d'utilisation et de l'environnement d'installation. L'utilisation consécutive pendant plus de 10 heures du projecteur ou de la commutation fréquente peuvent en particulier affecter considérablement la durée de vie de la lampe.

**Composants optiques**

- Si vous utilisez la lampe 6 heures consécutivement chaque jour, les composants optiques pourraient nécessiter un remplacement dans moins d'un an.

# Remplacement de l'unité de la lampe

## ■ Avant de remplacer le l'Unité de la lampe



- Débrancher le cordon principal de la prise du secteur.
- Vérifier que l'**Unité de la lampe** ainsi que les pièces autour aient eu le temps de refroidir.
- Préparer un tournevis cruciforme.
- Contacter un centre de service après-vente agréé pour acheter une **Unité de la lampe** (ET-LAB50) de rechange.
- En cas d'installation du projecteur au plafond, ne jamais travailler directement dessous et éloigner le visage du projecteur.

### REMARQUE:

- Avant de remplacer la lampe, la laisser refroidir pour éviter les risques de brûlures, les dommages et autres dangers.
- Ne pas essayer de la remplacer par une lampe non autorisée.

## ■ Délai de remplacement de l'Unité de la lampe

La lampe est un produit qui doit être remplacé. Même si la durée de vie complète de l'ampoule n'est pas encore épuisée, la luminosité de la lampe diminuera progressivement. Il faut donc remplacer périodiquement la lampe. L'intervalle de remplacement de la lampe prévu est de 2 000 heures; il est toutefois possible qu'il faille remplacer la lampe avant ce délai en raison d'éléments variables comme les caractéristiques particulières de la lampe, les conditions d'utilisation et l'environnement d'installation. Il est recommandé de toujours avoir un bloc de lampe de rechange prêt à l'emploi. La lampe s'éteindra automatiquement après environ 10 minutes lorsque la limite de 2 000 heures d'utilisation est atteinte, car le risque d'explosion de la lampe devient beaucoup plus grand passé cette limite.

Indication	A l'écran	Indicateur <b>LAMPE</b>
<b>Plus de 2 800 heures</b>		
<b>Plus de 3 000 heures</b>	<p>«<b>REEMPLACER LA LAMPE</b>» s'affiche en haut à gauche de l'écran, et attend votre réponse. Pour le supprimer immédiatement, appuyer sur n'importe quelle touche.</p>	S'allume en <b>ROUGE</b> .

### REMARQUE:

- Les heures d'utilisation expliquées ci-dessus concernent l'utilisation lorsque "PUISSANCE DE LA LAMPE" dans le menu "OPTION" a été réglée sur "MODE STANDARD" et lorsque "AI" dans le menu "IMAGE" a été réglé sur "NON". Si "PUISSANCE DE LA LAMPE" est réglée sur "MODE ÉCO", ou si "AI" est réglé sur "OUI", la durée de vie de la lampe peut être allongée.
- Bien que le délai de 2 000 heures soit l'intervalle de remplacement prévu, l'obtention de cette durée n'est pas couverte par la garantie.

## ■ Procédure de remplacement

### REMARQUE:

- Si la durée d'utilisation de la lampe a dépassée 2 000 heures (lorsque "PUISSANCE DE LA LAMPE" a été réglé sur "MODE STANDARD" et lorsque "AI" a été réglé sur "NON"), le projecteur passe en mode d'attente après environ 10 minutes de fonctionnement. Dès lors, faire les étapes 7 à 12 dans les 10 minutes.

1. Débrancher le cordon d'alimentation du projecteur en procédant comme indiqué à la page 20, puis vérifier si la zone environnant le bloc de lampe s'est bien refroidie.
2. Utiliser un tournevis Phillips pour desserrer les vis de fixation du couvercle du bloc de lampe sur le fond du projecteur, puis enlever le couvercle du bloc de lampe.

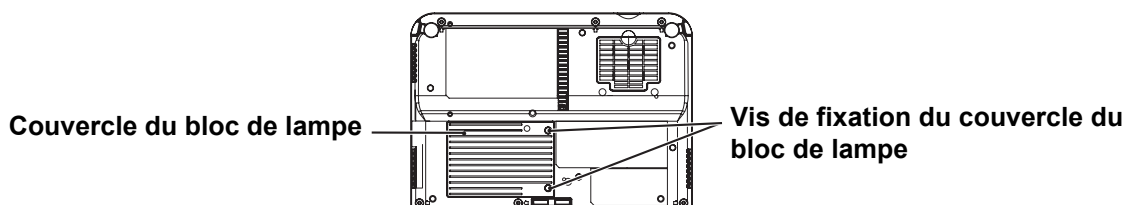

3. Utiliser un tournevis Phillips pour desserrer les deux vis de fixation du bloc de lampe jusqu'à ce que les vis tournent librement. Puis tenir les poignées du bloc de lampe et tirer doucement le bloc de lampe pour le faire sortir du projecteur.

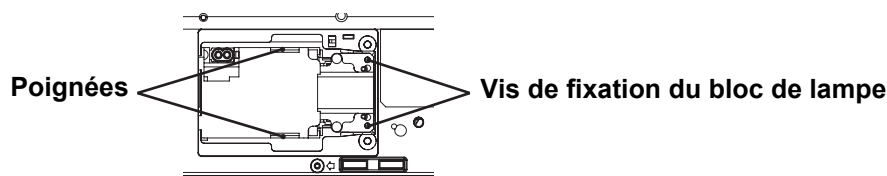

4. Insérer le bloc de lampe neuf tout en s'assurant que le sens d'insertion est correct, puis utiliser un tournevis Phillips pour resserrer fermement les vis de fixation du bloc de lampe.
  - Lors de l'insertion du bloc de lampe neuf, veiller à le pousser aux points (A) et (B).

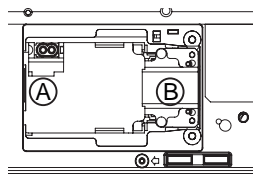

5. Installer le couvercle du bloc de lampe, puis utiliser un tournevis Phillips pour resserrer fermement les vis de fixation du couvercle du bloc de lampe.

### REMARQUE:

- S'assurer de bien installer le bloc de lampe et le couvercle du bloc de lampe. S'ils ne sont pas bien installés, cela peut déclencher le circuit de protection et le projecteur ne pourra pas être allumé.

6. Brancher le cordon d'alimentation.
7. Appuyer sur la touche POWER pour projeter une image sur l'écran.

### REMARQUE:

- Si "DÉMARRAGE DIRECT" a été réglé sur "OUI" dans le menu "OPTION", la projection démarrera une fois que le cordon d'alimentation aura été connecté. Pour plus de détails, se référer à la page 35.

8. Appuyer sur la touche MENU pour faire apparaître l'écran de menu, puis appuyer sur la touche ▲ ou ▼ pour sélectionner le menu "OPTION".
9. Appuyer sur la touche ENTER, puis appuyer sur la touche ▲ ou ▼ pour sélectionner "DURÉE DE LA LAMPE".
10. Maintenir la touche ENTER enfoncée pendant environ 3 secondes.
  - L'écran "DURÉE LAMPE" apparaît alors.

### REMARQUE:

- Appuyer sur une touche autre que la touche POWER pour annuler l'écran "DURÉE LAMPE".

11. Appuyer sur la touche POWER pour éteindre le projecteur.
12. Débrancher le cordon d'alimentation après que la touche POWER du projecteur s'allume en rouge.
  - Le temps d'utilisation total du bloc de lampe est alors remis à zéro.

**NOTE:**

This product contains a CR Coin Cell Lithium Battery which contains Perchlorate Material - special handling may apply.

See [www.dtsc.ca.gov/hazardouswaste/perchlorate](http://www.dtsc.ca.gov/hazardouswaste/perchlorate).

---

# Panasonic<sup>®</sup>

Projectors

---

**Panasonic Projector Systems Company**

Unit of Panasonic Corporation of North America

One Panasonic Way, Secaucus, NJ 07094  
(201) 392 - 6591

**Technical Support:**

(888) 411 - 1996

FAX: (201) 348 - 7523

E-Mail: [projectorsupport@us.panasonic.com](mailto:projectorsupport@us.panasonic.com)

© 2007 Matsushita Electric Industrial Co., Ltd. All Rights Reserved.

Printed in Japan  
S0607-1077B